

Industrial Wall-mount Managed Gigabit Ethernet Switch

WGS-804HPT/WGS-4215-8T/

WGS-4215-8T2S/WGS-4215-8P2S

Quick Installation Guide

Table of Contents

| | |
|--|----|
| 1. Package Contents | 3 |
| 2. Requirements | 4 |
| 3. Wiring the Power Inputs..... | 5 |
| 3.1 Terminal Block Connector Pinout | 6 |
| 4. Installation..... | 7 |
| 4.1 Wall Mount Installation..... | 7 |
| 4.2 Magnet Installation | 8 |
| 4.3 DIN-rail Mount Installation | 8 |
| 5. Starting Web Management | 10 |
| 6. Saving Configuration via the Web | 13 |
| 7. Recovering Back to Default Configuration..... | 14 |
| 8. Customer Support | 15 |

1. Package Contents

Thank you for purchasing PLANET Industrial Wall-mount Managed Gigabit Switch, WGS-804HPT/WGS-4215-8T/WGS-4215-8T2S/WGS-4215-8P2S. The table below shows the models with the number of ports:

| Model Name | 10/100/1000T Copper Ports | 802.3at PoE Ports | 100/1000 SFP Fiber Optical Interface |
|---------------|---------------------------|-------------------|--------------------------------------|
| WGS-804HPT | 8 | 4 | — |
| WGS-4215-8T | 8 | — | — |
| WGS-4215-8T2S | 8 | — | 2 |
| WGS-4215-8P2S | 8 | 8 | 2 |

In the following section, unless specified, the term **“Wall-mount Managed Switch”** mentioned in this quick installation guide refers to the WGS-804HPT/WGS-4215-8T/WGS-4215-8T2S/WGS-4215-8P2S.

Open the box of the Wall-mount Managed Switch and carefully unpack it. The box should contain the following items:

- The Wall-mount Managed Switch x 1
- Quick Installation Guide x 1
- 3-pin Terminal Block Connector x 1
- Wall-mounted Kit x 1
- DIN-rail Kit x 1
- Magnet Kit x 1
- RJ45 Dust Cap x 8
- SFP Dust Cap x 2 (WGS-4215-8T2S/WGS-4215-8P2S only)

If any item is found missing or damaged, please contact your local reseller for replacement.

2. Requirements

- Workstations running Windows XP/2003/Vista/7/8/2008/10, MAC OS X or later, Linux, UNIX, or other platforms are compatible with TCP/IP protocols.
- Workstations are installed with Ethernet NIC (Network Interface Card)
- Ethernet Port Connection
 - Network cables -- Use standard network (UTP) cables with RJ45 connectors.
 - The above PC is installed with Web browser and JAVA runtime environment plug-in.



Note

It is recommended to use Internet Explorer 8.0 or above to access the Wall-mount Managed Switch. If the Web interface of the Wall-mount Managed Switch is not accessible, please turn off the anti-virus software or firewall and then try it again.

3. Wiring the Power Inputs

The Wall-mount Managed Switch features a strong dual power input system (Terminal block and DC jack) incorporated into customer's automation network to enhance system reliability and uptime.

| Model \ Power Input Range | 3-pin Terminal Block | DC Jack |
|---------------------------|----------------------|-------------------|
| WGS-804HPT | 48~56V DC | 48~56V DC |
| WGS-4215-8T | 12~48V DC, 24V AC | 12~48V DC, 24V AC |
| WGS-4215-8T2S | 12~48V DC, 24V AC | 12~48V DC |
| WGS-4215-8P2S | 48~56V DC | 48~56V DC |

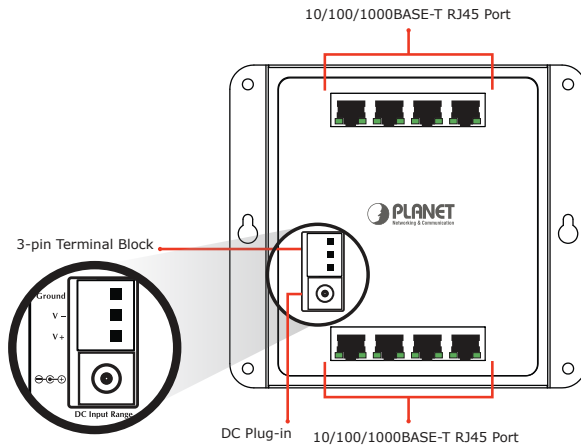

3.1 Terminal Block Connector Pinout

To install the 3-pin Terminal Block Connector on the Wall-mount Managed Switch, simply follow the following steps:

Step 1: Insert positive DC power wire into **V+**, negative DC power wire into **V-**, and grounding wire into **Ground**.

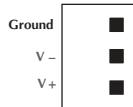

Step 2: Tighten the wire-clamp screws for preventing the wires from loosening and plug into the Wall-mount Managed switch.



Note

1. The wire gauge should be in the range from 12 to 24 AWG.
2. The device must be grounded.

4. Installation

4.1 Wall Mount Installation

To install the Wall-mount Managed Switch on the wall, simply follow the following steps:

- Step 1:** There are 4 holes with 8mm diameter on the wall; the distance between the 2 holes is 133mm (WGS-804HPT/WGS-4215-8T), 163mm (WGS-4215-8T2S/WGS-4215-8P2S) and the line through them must be horizontal.
- Step 2:** Install a conductor pipe inside the board hole and flush the edge of the conductor pipe with the wall surface.
- Step 3:** Screw the bolts into the conductor pipe. The Wall-mount Managed Switch is between bolts and conductor pipe, as shown below.

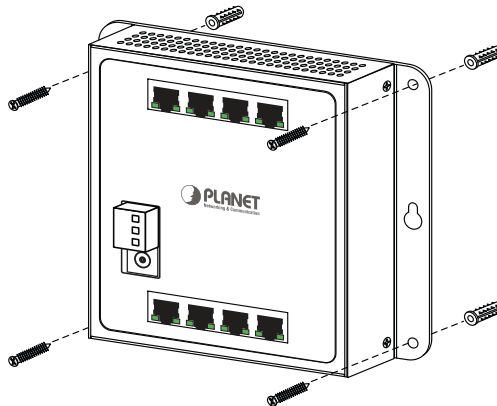

4.2 Magnet Installation

To install the Wall-mount Managed Switch on a magnetic surface, simply follow the following diagram:

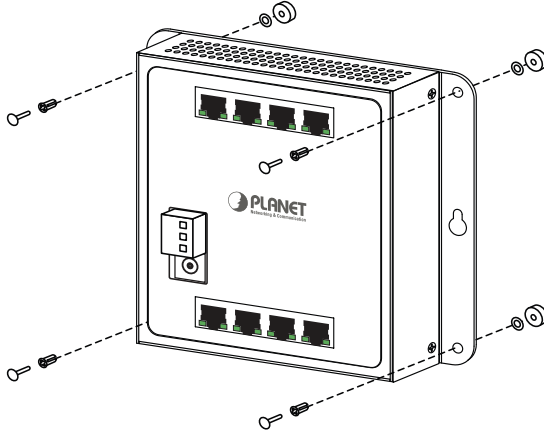

4.3 DIN-rail Mount Installation

The DIN-rail kit is included in the package. When the wall-mount application for the Wall-mount Managed Switch needs to be replaced with DIN-rail application, please refer to the following figures to screw the DIN-rail on the Wall-mount Managed Switch. To hang up the Wall-mount Managed Switch, follow the steps below:

Step 1: Screw the DIN-rail on the Wall-mount Managed Switch.

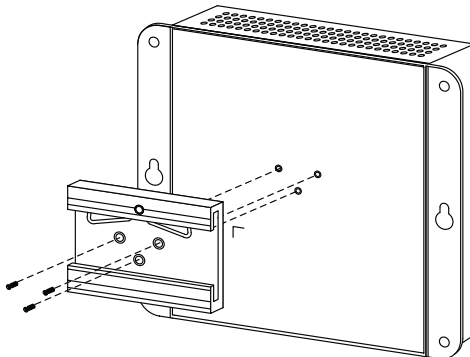

Step 2: Lightly insert the button of DIN-rail into the track.

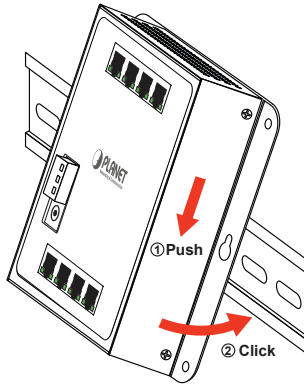

Step 3: Check whether the DIN-rail is tightly on the track.

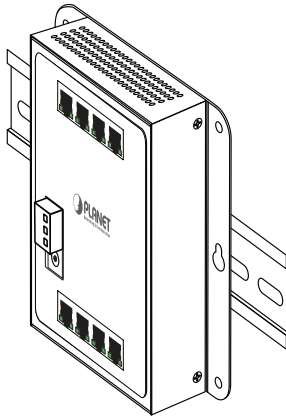

5. Starting Web Management

The following shows how to start up the **Web Management** of the Wall-mount Managed Switch. Note the Wall-mount Managed Switch is configured through an Ethernet connection. Please make sure the manager PC must be set to the same **IP subnet address**.

For example, the default IP address of the Wall-mount Managed Switch is **192.168.0.100**, then the manager PC should be set to **192.168.0.x** (where x is a number between 1 and 254, except 100) and the default subnet mask is 255.255.255.0.

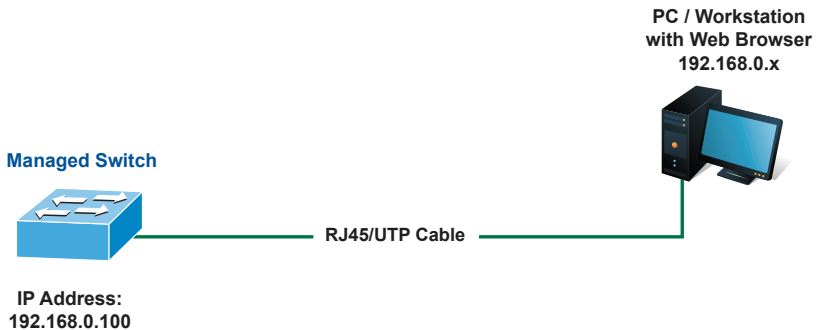

Figure 5-1: IP Management Diagram

Logging in to the Wall-mount Managed Switch

1. Use Internet Explorer 8.0 or above Web browser and enter IP address **<http://192.168.0.100>** to access the Web interface.
2. When the following dialog box appears, please enter **"admin"** in both the default user name and password fields. The login screen in Figure 5-2 appears.

Default Username: **admin**

Default Password: **admin**

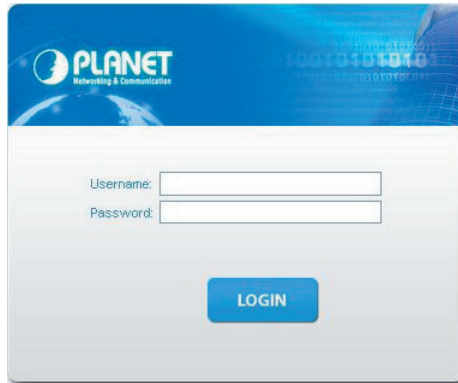

Figure 5-2: Web Login Screen

3. After entering the password, the main screen appears as Figure 5-3 shows.



Note

The following web screen is based on the WGS-4215-8T2S. The display of the WGS-4215-8T2S is the same as those of the WGS-804HPT and WGS-4215-8T/WGS-4215-8P2S.

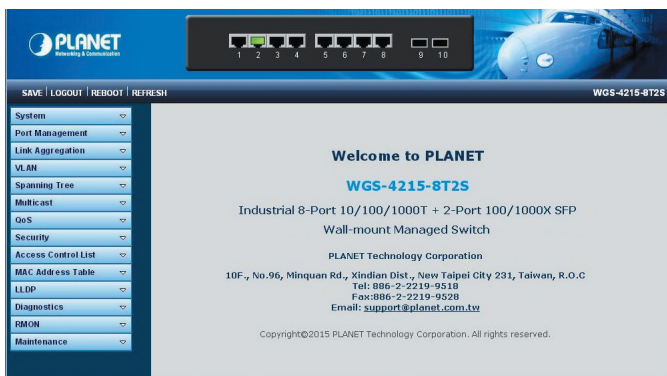

Figure 5-3: Web Main Screen of Wall-mount Managed Switch

The Switch Menu on the left of the Web page lets you access all the commands and statistics the Wall-mount Managed Switch provides.

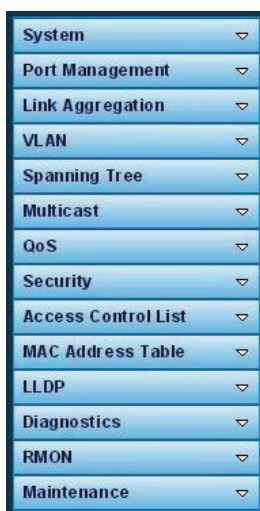

Figure 5-4: Switch Menu

Now, you can use the Web management interface to continue the Switch management. Please refer to the user's manual for more.

6. Saving Configuration via the Web

In the Wall-mount Managed Switch, the running configuration file stores in the RAM. In the current version, the running configuration sequence of running-config can be saved from the RAM to FLASH by **“Save Configurations to FLASH”** function, so that the running configuration sequence becomes the startup configuration file, which is called configuration save.

To save all applied changes and set the current configuration as a startup configuration, the startup-configuration file will be loaded automatically across a system reboot.

1. Click **“Save > Save Configurations to FLASH”** to login “Configuration Manager” Page.

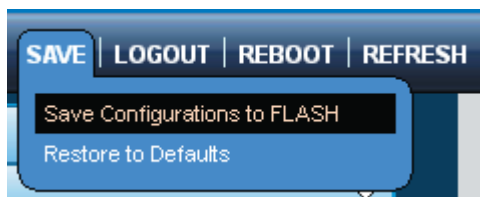

2. Press the **“Apply”** button to save running configuration to start up configuration.

| Configuration Manager | |
|--------------------------------------|---|
| Save Configuration | |
| Source File | <input checked="" type="radio"/> Running configuration <input type="radio"/> Startup configuration <input type="radio"/> Backup configuration |
| Destination File | <input checked="" type="radio"/> Startup configuration <input type="radio"/> Backup configuration |
| <input type="button" value="Apply"/> | |

7. Recovering Back to Default Configuration

IP Address has been changed or admin password has been forgotten –

To reset the IP address to the default IP address “**192.168.0.100**” or reset the login password to default value, press the **reset button** on the front panel for about **5 seconds**. After the device is rebooted, you can login the Web interface management within the same subnet of 192.168.0.xx.

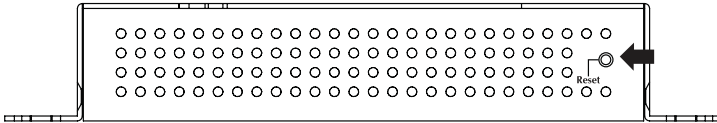

Figure 7-1: WGS-804HPT/WGS-4215-8T Reset Button

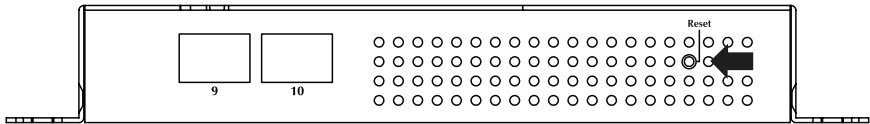

Figure 7-2: WGS-4215-8T2S/WGS-4215-8P2S Reset Button

8. Customer Support

Thank you for purchasing PLANET products. You can browse our online FAQ resource and User's Manual on PLANET Web site first to check if it could solve your issue. If you need more support information, please contact PLANET switch support team.

PLANET online FAQ:

<http://www.planet.com.tw/en/support/faq.php?type=1>

Switch support team mail address:

support_switch@planet.com.tw

WGS-804HPT/WGS-4215-8T/WGS-4215-8T2S/WGS-4215-8P2S User's Manual:

<http://www.planet.com.tw/en/support/download.php?type1=22153&model=&type=3>



Copyright © PLANET Technology Corp. 2016.

Contents are subject to revision without prior notice.

PLANET is a registered trademark of PLANET Technology Corp. All other trademarks belong to their respective owners.

