

**Gigabit Ethernet over VDSL2  
Converter/Bridge**

**VC-231G/VC-234G**

User's Manual

## ■ Trademarks

Copyright © PLANET Technology Corp. 2017.

Contents are subject to revision without prior notice.

PLANET is a registered trademark of PLANET Technology Corp. All other trademarks belong to their respective owners.

## ■ Disclaimer

PLANET Technology does not warrant that the hardware will work properly in all environments and applications, and makes no warranty and representation, either implied or expressed, with respect to the quality, performance, merchantability, or fitness for a particular purpose.

PLANET has made every effort to ensure that this User's Manual is accurate; PLANET disclaims liability for any inaccuracies or omissions that may have occurred.

Information in this User's Manual is subject to change without notice and does not represent a commitment on the part of PLANET. PLANET assumes no responsibility for any inaccuracies that may be contained in this User's Manual. PLANET makes no commitment to update or keep current the information in this User's Manual, and reserves the right to make improvements to this User's Manual and/or to the products described in this User's Manual, at any time without notice.

If you find information in this manual that is incorrect, misleading, or incomplete, we would appreciate your comments and suggestions.

## ■ FCC Warning

This equipment has been tested and found to comply with the limits for a Class A digital device, pursuant to Part 15 of the FCC Rules. These limits are designed to provide reasonable protection against harmful interference when the equipment is operated in a commercial environment. This equipment generates, uses, and can radiate radio frequency energy and, if not installed and used in accordance with the Instruction manual, may cause harmful interference to radio

communications. Operation of this equipment in a residential area is likely to cause harmful interference in which case the user will be required to correct the interference at his own expense.

### ■ CE Mark Warning

This is a Class A product. In a domestic environment, this product may cause radio interference, in which case the user may be required to take adequate measures.

### ■ Energy Saving Note of the Device

This power required device does not support Standby mode operation.

For energy saving, please remove the power cable to disconnect the device from the power circuit.

Without removing power cable, the device will still consume power from the power source. In view of Saving the Energy and reducing the unnecessary power consumption, it is strongly suggested to remove the power connection for the device if this device is not intended to be active.

### ■ WEEE Warning



To avoid the potential effects on the environment and human health as a result of the presence of hazardous substances in electrical and electronic equipment, end users of electrical and electronic equipment should understand the meaning of the crossed-out wheeled bin symbol. Do not dispose of WEEE as unsorted municipal waste and have to collect such WEEE separately.

### ■ Revision

PLANET Gigabit Ethernet over VDSL2 Converter/Bridge User's Manual

For Models: VC-231G, VC-234G

Revision: 1.1 (August 2017)

Part No.: 2350-AC0500-001







# Table of Contents

1. Package Contents .....	5
2. Product Features .....	6
3. Hardware Introduction .....	8
3.1 Front Panel and LED Indicators .....	8
3.2 Rear Panel and Mode DIP Switch .....	11
3.3 Power Information .....	15
4. Connecting And Using The VDSL2 Bridge .....	16
4.1 Point-to-Point Application--LAN to LAN Connection.....	18
4.2 Point-to-Multipoint Application--Connect to IP DSLAM....	19
5. Product Specifications .....	22
6. Performance Table .....	24
7. Troubleshooting .....	26
8. FAQs .....	27
9. Customer Support .....	29
Appendix: Wall-mount and Chassis Installation .....	30

## 1. Package Contents

Thank you for purchasing PLANET Gigabit Ethernet over VDSL Converter/Bridge, VC-231G/VC-234G. In the following section, the term **"VDSL2 Bridge"** means the VC-231G or VC-234G

Open the box of the VDSL2 Bridge and carefully unpack it. The box should contain the following items:

VC-231G	VC-234G	User's Manual x 1
		
5V, 2A Power Adapter x 1	Splitter x 1 (VC-231G only)	RJ11 Telephone Wire x 1
		

If any of these are missing or damaged, please contact your dealer immediately; if possible, retain the carton including the original packing material, and use them again to repack the product in case there is a need to return it to us for repair.

## 2. Product Features

### ■ Physical

- VC-231G
  - 1 10/100/1000BASE-T RJ45 auto-MDI/MDI-X ports
  - 1 RJ11, connector for VDSL port with VDSL connection
  - Additional splitter for POTS connection
- VC-234G
  - 4 10/100/1000BASE-T RJ45 auto-MDI/MDI-X ports
  - 1 RJ11, built-in splitters for POTS connection
  - 1 VDSL2 RJ11 female phone jack

### ■ Product Features

- Cost-effective bridge function to connect two Ethernet LANs
  - ◆ Point-to-multipoint application: Compatible with PLANET and third-party VDSL2 IP DSLAM for last-mile solution
  - ◆ Point-to-point application: LAN to LAN extension over phone wire
- Up to 150/150Mbps bandwidth (in **G.INP, Sym, 8dB** mode)
- ITU-T G.993.2 VDSL2 standard
- ITU-T G.993.5 G.vectoring and G.INP
- DMT-based coding technology
- POST splitter to share voice and data
- CO/CPE mode selectable via DIP switch
- Selectable target band plan (symmetric and asymmetric) and SNR margin
- Half duplex back pressure and IEEE 802.3x full duplex pause frame flow control

- 
- Voice and data communication can be shared simultaneously based on the existing telephone wire with distance up to 1.4km
  - Supports a packet size of up to 9K bytes; IEEE 802.1Q VLAN tag transparency
  - VDSL2 stand-alone transceiver for simple bridge modem application
  - Advantage of minimum installation time (Simply by Plug and Play)
  - Supports extensive LED indicators for network diagnosis

### ■ Hardware Features

- Compact size, wall-mountable design
- Metal case, good for heat sinking
- Easy installation; ideal solution for space-limited locations
- Co-work with PLANET MC family Media Chassis (MC-700/MC-1500/MC-1500R/MC-1500R48)

## 3. Hardware Introduction

### 3.1 Front Panel and LED Indicators

#### ■ VC-231G Front Panel

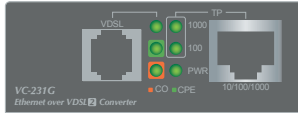

Figure 3-1-1: VC-231G Front Panel

- 10/100/1000BASE-T RJ45 connector for Ethernet
- RJ11 connector for VDSL2; connect to IP DSLAM or another VDSL2 Bridge
- LEDs for power, Ethernet and VDSL

#### ■ VC-231G LED Indicators

##### ◆ System

LED	Color	Function	
PWR	Green	Lit	Indicates that the VDSL2 Bridge has power.
		Off	Indicates that the VDSL2 Bridge has no power.

##### ◆ VDSL

LED	Color	Function	
VDSL	Green	Lit	Indicates that the VDSL link is established.
		Fast Blink	Indicates that the VDSL link is at training status (about 10 seconds).
		Slow Blink	Indicates that the VDSL link is at idle status.



CO	Green	Lit	Indicates the VDSL2 Bridge is running in <b>CO</b> mode.
CPE	Green	Lit	Indicates the VDSL2 Bridge is running in <b>CPE</b> mode.

◆ 10/100/1000BASE-T Port

LED	Color	Function	
1000	Green	Lit	Indicates that the port is operating at <b>1000Mbps</b> .
		Blink	Indicates that the VDSL2 Bridge is actively sending or receiving data over that port at <b>1000Mbps</b> .
		Off	Indicates that the port is <b>link down</b> or <b>10/100Mbps</b> .
100	Green	Lit	Indicates that the port is operating at <b>100Mbps</b> or <b>10Mbps</b> .
		Blink	Indicates that the VDSL2 Bridge is actively sending or receiving data over that port at <b>100Mbps</b> or <b>10Mbps</b> .
		Off	Indicates that the port is <b>link down</b> or <b>1000Mbps</b> .

■ VC-234G Front Panel



Figure 3-1-2: VC-234G Front Panel

- LEDs for power, Ethernet and VDSL

## ■ VC-234G LED Indicators

### ◆ System

LED	Color	Function	
PWR	Green	Lit	Indicates that the VDSL2 Bridge has power.
		Off	Indicates that the VDSL2 Bridge has no power.

### ◆ VDSL

LED	Color	Function	
VDSL	Green	Lit	Indicates that the VDSL link is established.
		Fast Blink	Indicates that the VDSL link is at training status (about 10 seconds).
		Slow Blink	Indicates that the VDSL link is at idle status.
CO	Green	Lit	Indicates the VDSL2 Bridge is running in <b>CO</b> mode.
CPE	Green	Lit	Indicates the VDSL2 Bridge is running in <b>CPE</b> mode.

### ◆ 10/100/1000BASE-T Port

LED	Color	Function	
1000	Green	Lit	Indicates that the port is operating at <b>1000Mbps</b> .
		Blink	Indicates that the VDSL2 Bridge is actively sending or receiving data over that port at <b>1000Mbps</b> .
		Off	Indicates that the port is <b>link down</b> or <b>10/100Mbps</b> .

100	Green	Lit	Indicates that the port is operating at <b>100Mbps</b> or <b>10Mbps</b> .
		Blink	Indicates that the VDSL2 Bridge is actively sending or receiving data over that port at <b>100Mbps</b> or <b>10Mbps</b> .
		Off	Indicates that the port is <b>link down</b> or <b>1000Mbps</b> .

## 3.2 Rear Panel and Mode DIP Switch

### ■ VC-231G Rear Panel



Figure 3-2-1: VC-231G Rear Panel

- DIP switch
- DC jack (DC input) for power adapter

### ■ VC-234G Rear Panel

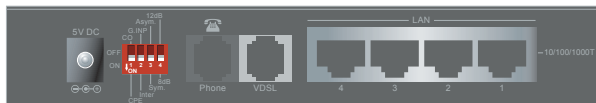

Figure 3-2-2: VC-234G Rear Panel

- Four 10/100/1000BASE-T RJ45 connectors for Ethernet
- One RJ11 connector for VDSL2; connect to IP DSLAM or another VDSL2 Bridge

- One RJ11 connector for telephone or PBX POTS
- DIP switch
- DC jack (DC input) for power adapter

## ■ DC Power Jack

The VC-234G/VC-231G requires 5V DC, 2A power input, which conforms to the bundled AC adapter. Should you have the issue of power connection, please contact your local sales representative.



The device is a power-required device, meaning it will not work till it is powered. If your networks should be active all the time, please consider using UPS (uninterrupted power supply) for your device. It will prevent you from network data loss or network downtime.



In some areas, installing a surge suppression device may also help to protect your Ethernet over VDSL2 Bridge from being damaged by unregulated surge or current to the Ethernet over VDSL2 Bridge or the power adapter.

## ■ DIP Switch

The Ethernet over VDSL2 Bridge provides 4 selective transmission modes. By switching the transmission modes, you can obtain a best transmission mode to suit with phone line quality or distance of connectivity. The following is the summary table of transmission setting, bandwidth and distance extensibility tested for AWG 24 (0.5mm) twisted-pair without noise and cross talk.

	<b>DIP-1</b>	<b>DIP-2</b>	<b>DIP-3</b>	<b>DIP-4</b>
	Mode	Transmission	Band Profile	SNR Margin
OFF	CO	G.INP	Asymmetric	12dB
ON (default)	CPE	Interleave	Symmetric	8dB

◆ DIP-1: Mode (CO/CPE)

CO (Central Office)	The Master device mode, usually the CO device, is located at the data center of ISP or enterprise to link to the backbone.
CPE (Customer Premises Equipment)	The Slave device mode, usually the CPE device, is located at branch office, home or remote side as the long reach data receiver. The CPE can be connected to the PC, IP camera or wireless access point or other network devices.



Note

When the VDSL2 Bridge operates in **CPE mode**, DIP switches 2, 3, and 4 are **without function**.

◆ DIP-2: Transmission (G. INP and Interleave mode)

G. INP	Method of protection against bursts from other devices or lines to impact your xDSL line.
Interleave	Method of error correction used on xDSL line. Interleave requires additional latency to improve resilience to burst of error.

◆ DIP-3: Band Profile (Asymmetric/Symmetric)

Asymmetric	Asymmetric mode provides more bandwidth than the other side. This mode provides the highest bandwidth in short range.
Symmetric	With G.997 band plan supported, symmetric mode can provide almost the same rate of downstream and upstream.

◆ DIP-4: SNR (Signal Noise Ratio) Margin

When the SNR margin is selected, the system provides 12dB/8dB SNR margin for across all usable loop lengths. Better channel noise protection is made with the higher SNR margin.



Note

By default, the four DIP switches, set at the **"ON"** position, are operated as **"CPE"**. For operating as **"CO"**, please turn DIP 1 Switch to the **"OFF"** position. Then adjust the other DIP switches accordingly to fulfill different network application demands.



Note

Please **power off** the VDSL2 Bridge before making any transmission mode adjustment.

### 3.3 Power Information

The central posts of the VC-231G's and VC-234G's power jacks measure 2.5mm wide that require +5VDC power input. They conform to the bundled AC-DC adapter and Planet's media chassis. Should you have the issue of power connection, please contact your local sales representative.

Please keep the AC-DC adapter as a spare part when the VC-231G is installed to a media chassis.



Width of DC Receptacle: 2.5mm

+5V for each slot



DC receptacle is 2.5mm wide that matches the central post, measuring 2.5mm wide, of the VDSL2 converter's DC jack. Do not install any improper unit.

## 4. Connecting And Using The VDSL2 Bridge

The Ethernet to VDSL2 Bridge does not require any software configuration. Users can immediately use any feature of this product simply by putting the plug in the receptacle and turning it on. There is some key limitation on the VDSL2 Bridge. Please check the following items:

- The device can be used for **Point-to-Point** (one **CO** device to one **CPE** device) connection or **Point-to-Multipoint** (one multi-port **CO** device to multi **CPE** devices) and allows data and voice to work on the same telephone lines.
- The VC-231G provides only one RJ11 connector for VDSL2 port to build VDSL2 connection. For voice device connection, there is an additional splitter from the package of the VC-231G, which is an ideal choice.
- The VC-234G provides two RJ11 connectors for VDSL2 port. One for voice device connection (like telephone) and the other one for VDSL2 network link connection.
- Depending on the quality of telephone line, the maximum distance of one VDSL2 segment is 1.4km (4593ft) with AWG 24 telephone wires. The distance could vary on the quality of telephone wires.



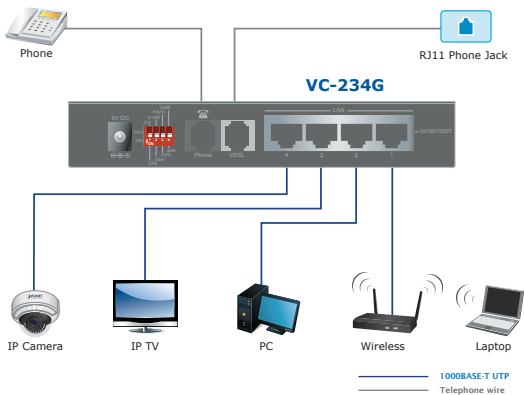
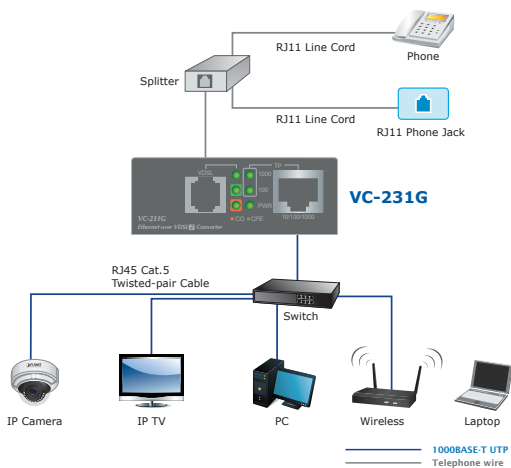

## 4.1 Point-to-Point Application -- LAN to LAN Connection

Two sets of the VDSL2 Bridge could be used to link two local Area networks that are located in a different place. Through the normal telephone line, it could be set up a **150/150Mbps** (G.INP, Sym, 8dB) symmetric backbone, but one VDSL2 Bridge must be Master (**CO mode**) and the other one is Slave (**CPE mode**).

### LAN to LAN Connection

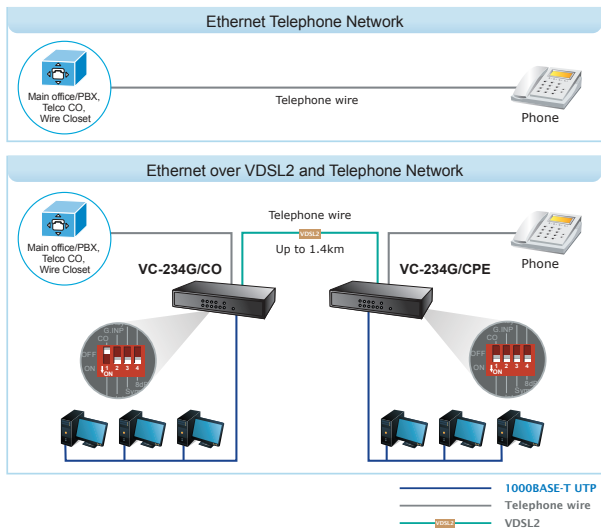

---

Refer to the following procedures to set up the VC-234G/VC-231G LAN to LAN connection.

1. **[LAN1]** Set the VC-234G/VC-231G at LAN 1 to be **CO** mode from the DIP switch.
2. **[LAN2]** Set the VC-234G/VC-231G at LAN 2 to be **CPE** mode from the DIP switch.
3. Power on the VC-234G/VC-231G CO and CPE at both sides by connecting its power source.
4. Power LED will illuminate.
5. Connect VDSL line from another VDSL device to RJ11 **VDSL port** of the VC-234G/VC-231G.
6. **VDSL LNK LED** will blink to illuminate at both VDSL2 bridges.
7. Connect telephone to the RJ11 **Phone port** of the VC-234G/VC-231G.
8. Connect the VC-234G/VC-231G Ethernet **LAN port** to other network device via regular Cat.5 UTP cable.

## 4.2 Point-to-Multipoint Application -- Connect to IP DSLAM

To build a local Internet in apartments, hotels and campuses and hospitality environments, it requires:

The multi-port VDSL2 IP DSLAM or VDSL2 switch (for example, PLANET VDL-2420M and VC-820M) operates as a **CO Master** and needs to be placed in the wiring center (MDF room) and connects to the telephone line system.

On the other hand, it needs to install one or many **CPE Slaves** (the VC-231G or VC-234G VDSL Bridge) on the individual client side and connect to the multi-port Master through the telephone lines.

## Multi-LAN Connection

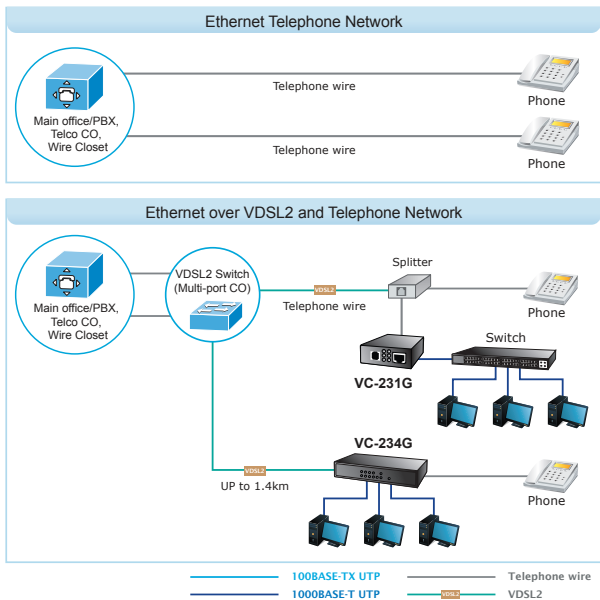

Refer to the following procedure to set up the VC-234G/VC-231G to IP DSLAM connection.

1. **[Remote End]** Set the remote IP DSLAM/VDSL2 switch to **CO** mode with proper VDSL2 profile.
2. **[Local End]** Set the VC-234G/VC-231G at the local end to **CPE** mode from the DIP switch
3. Power on the VC-234G/VC-231G CPEs by connecting its power source.

- 
- 4. Power LED will illuminate.
  - 5. Connect VDSL line from IP DSLAM/VDSL2 switch to RJ11 **VDSL port** of the VC-234G/VC-231G.
  - 6. **VDSL LNK LED** will blink to illuminate.
  - 7. Connect telephone to the RJ11 **Phone port** of the VC-234G/VC-231G.
  - 8. Connect the VC-234G/VC-231G Ethernet **LAN port** to other network device via regular Cat.5 UTP cable.

When deciding where to put the converter and / or prolong the operational life of the bridge, please also refer to the following points:

- It is accessible and cables can be connected easily.
- Cabling is away from sources of electrical noise such as radios, transmitters, motors, power lines and fluorescent lighting fixtures.
- Do not place objects on top of any unit or stack.
- Water or moisture cannot enter the VDSL2 Bridge.
- Air flowing around the unit and through the vents on the side of the case is not restricted (We recommend that you provide a minimum of 25mm clearance).

## 5. Product Specifications

Product	VC-231G	VC-234G
Hardware Specifications		
LAN Ports	1 10/100/1000BASE-T RJ45 auto-MDI/MDI-X ports	4 10/100/1000BASE-T RJ45 auto-MDI/MDI-X ports
VDSL Port	1 VDSL2 RJ11 female phone jack Twisted-pair telephone wires (AWG24 or better) up to 1.4km	
Phone Port	Additional splitter for POTS connection	1 RJ11, built-in splitters for POTS connection
Dimensions (W x D x H)	97 x 70 x 26 mm	154.6 x 86.0 x 26.3 mm
Weight	184g	350g
Power Requirement	DC 5V, 2A external power	
LED Indicators	<ul style="list-style-type: none"> <li>◆ Power: Green</li> <li>◆ 1000BASE-T LNK/ACT: Green</li> <li>◆ 100BASE-T LNK/ACK: Green</li> <li>◆ VDSL: Green</li> <li>◆ CO: Green</li> <li>◆ CPE: Green</li> </ul>	
Housing	Metal	
DIP Switch & Functionality	4-position DIP switch ◆ <b>CO/CPE</b> mode select ◆ Selectable <b>G.INP</b> and <b>interleaved</b> mode ◆ Selectable target <b>Band Profile</b> ◆ Selectable target <b>SNR mode</b>	

Switch Specifications	
Switch Processing Scheme	Store-and-Forward
Address Table	2K entries
Flow Control	Back pressure for half duplex IEEE 802.3x pause frame for full duplex
Jumbo Packet Size	9K bytes
System Specifications	
VDSL Compliance	<ul style="list-style-type: none"> <li>◆ VDSL-DMT               <ul style="list-style-type: none"> <li>➤ ITU-T G.993.1 VDSL</li> <li>➤ ITU-T G.997.1</li> <li>➤ ITU-T G.993.2 VDSL2 (Profile 17a/30a Support)</li> <li>➤ ITU-T G.993.5 <b>G. Vectoring</b></li> <li>➤ ITU-T G.998</li> <li>➤ G.INP</li> </ul> </li> </ul>
ADSL Compliance	<ul style="list-style-type: none"> <li>◆ Capable of <b>ADSL2/2+</b> standard               <ul style="list-style-type: none"> <li>➤ ITU G.992.3 G.dmt.bis</li> <li>➤ ITU G.992.5 G.dmt.bisplus</li> </ul> </li> <li>◆ Data Rate: Up to 24Mbps</li> </ul>
Standards Conformance	
Standards Compliance	IEEE 802.3 Ethernet IEEE 802.3u Fast Ethernet IEEE 802.3ab Gigabit Ethernet IEEE 802.3x Full-duplex Flow Control IEEE 802.1p Class Of Service ITU-T G.993.1 VDSL ITU-T G.997.1 ITU-T G.993.2 VDSL2 (Profile 17a/30a Support) ITU-T G.993.5 G.Vectoring & G.INP ITU-T G.998

## 6. Performance Table

### ■ VC-231G Performance, unit: Mbps

Distance (meter)	Interleave (Downstream/Upstream)			
	Asymmetric		Symmetric	
	8dB	12dB	8dB	12dB
200m	190/87	178/84	147/139	135/127
400m	161/60	143/53	112/110	96/96
600m	118/36	99/32	75/73	61/59
800m	59/24	48/22	44/44	40/40
1000m	47/7	41/5	26/25	23/18
1200m	39/4	33/3	24/13	22/9
1400m	25/4	23/3	20/9	16/7
Distance (meter)	G.INP (Downstream/Upstream)			
	Asymmetric		Symmetric	
	8dB	12dB	8dB	12dB
200m	197/101	185/89	150/150	140/140
400m	168/65	148/54	117/117	97/97
600m	109/34	95/32	77/77	60/60
800m	65/20	58/14	43/43	35/35
1000m	53/7	46/6	29/28	26/21
1200m	44/4	37/3	27/15	25/11
1400m	28/4	25/3	22/10	18/8



## ■ VC-234G Performance, unit: Mbps

Distance (meter)	Interleave (Downstream/Upstream)			
	Asymmetric		Symmetric	
	8dB	12dB	8dB	12dB
200m	193/89	180/80	142/139	137/129
400m	164/69	145/57	116/118	99/102
600m	112/39	95/32	70/73	54/61
800m	70/14	60/13	50/40	41/35
1000m	46/7	39/6	24/24	22/19
1200m	37/4	31/3	21/13	19/8
1400m	21/4	18/2	10/6	7/3
Distance (meter)	G.INP (Downstream/Upstream)			
	Asymmetric		Symmetric	
	8dB	12dB	8dB	12dB
200m	200/100	185/90	148/147	142/136
400m	170/68	150/60	120/126	103/110
600m	113/37	94/36	73/78	57/65
800m	70/18	61/14	48/43	38/36
1000m	51/7	44/6	27/26	14/13
1200m	44/5	35/3	25/13	23/8
1400m	24/2	21/1	10/5	8/3

The actual data rate will vary on the quality of the copper wire and environmental factors.

---

## 7. Troubleshooting

### ■ SYMPTOM:

VDSL LNK LED does not light up after wire is connected to the VDSL port.

### ■ CHECKPOINT:

1. Verify the length of the wire (not more than 1.4km) connected between the VC-231G and the VC-234G. Please also try to adjust the DIP switch or the VC-231G/VC-234G to the other SNR mode.
2. Please note you must use one VC-231G/VC-234G in CO mode and the other VC-231G/VC-234G in CPE mode to make connection to each other work.

### ■ SYMPTOM:

TP LED does not light after cable is connected to the port.

### ■ CHECKPOINT:

1. Verify you are using the Cat.5 or better cable with RJ45 connector to connect to the port.
2. If your device (like LAN card) supports to auto-negotiation, please try to manually set at a fixed speed of your device to solve this issue.
3. The Converter/Bridge and the connected device's power are on or not.
4. The port's cable is firmly seated in its connectors in the switch and in the associated device.
5. The connecting cable is good and with the correct type.
6. The connecting device, including any network adapter, is functional.

---

## 8. FAQs

**Q1:** What is VDSL2?

**A1:** VDSL2 (Very High-Bit-Rate Digital Subscriber Line 2), G.993.2, is the newest and most advanced standard of xDSL broadband wire line communications.

Designed to support the wide deployment of Triple Play services such as voice, data, high definition television (HDTV) and interactive gaming, VDSL2 enables operators and carrier to gradually, flexibly, and cost efficiently upgrade the existing xDSL-infrastructure.

**Q2:** What is SNR and what's the effect?

**A2:** In analog and digital communications, Signal-to-Noise Ratio, often written as SNR, is a measure of signal strength relative to background noise. The ratio is usually measured in decibels (dB).

In digital communications, the SNR will probably cause a reduction in data speed because of frequent errors that require the source (transmitting) computer or terminal to resend some packets of data. SNR measures the quality of a transmission channel over a network channel. The greater the ratio, the easier it is to identify and subsequently isolate and eliminate the source of noise.

Generally speaking, the higher SNR value gets, the better the line quality gets, but performance is lower.

**Q3:** What is the best distance for the VC-231G/VC-234G?

**A3:** In order to guarantee the stability and better quality of network, we suggest the distance should not exceed 1.4 kilometers.

---

**Q4:** What is the best data rate for the VC-231G/VC-234G?

**A4:** The best data rate of the VC-231G is up to 190Mbps/100Mbps (downstream/upstream) in asymmetric mode and 150Mbps/150Mbps in symmetric mode over a distance of 200 meters. The VC-234G provides a data rate of up to 200Mbps/100Mbps (downstream/upstream) in asymmetric mode and 150Mbps/150Mbps in symmetric mode over a distance of 200 meters.

---

## **9. Customer Support**

Thank you for purchasing PLANET products. You can browse our online FAQ resource on PLANET Website first to check if it could solve your issue. If you need more support information, please contact PLANET switch support team.

PLANET online FAQ:

<http://www.planet.com.tw/en/support/faq.php?type=1>

Switch support team mail address:

[support@planet.com.tw](mailto:support@planet.com.tw)

Copyright PLANET Technology Corp. 2017.

Contents are subject to revision without prior notice.

PLANET is a registered trademark of PLANET Technology Corp. All other trademarks belong to their respective owners.

## Appendix: Wall-mount and Chassis Installation

This part describes how to install your VDSL2 Bridge and make connections to it.

Please read the following topics and perform the procedures in the order being presented.

### ■ Wall-mount Installation

**Step 1:** Please find the wall that can mount the VC-234G/VC-231G

**Step 2:** Screw two screws on the wall.

**Step 3:** Hang the VC-234G/VC-231G on the screws from the wall.

**Step 4:** Refer to chapter 3.3 Power Information for power supply to the VC-234G/VC-231G.



Note

Before mounting the device to the wall, please check the location of the electrical outlet and the length of the Ethernet cable.

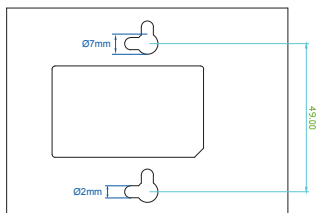

VC-231G Switch Bottom Side

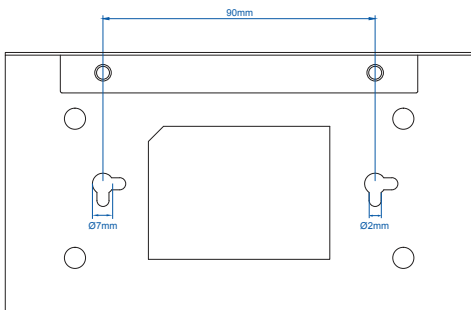
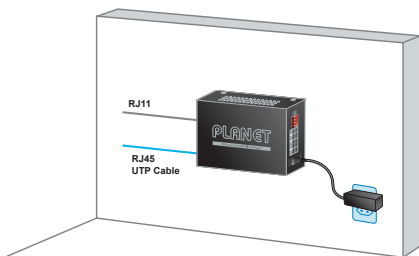

VC-234G Switch Bottom Side

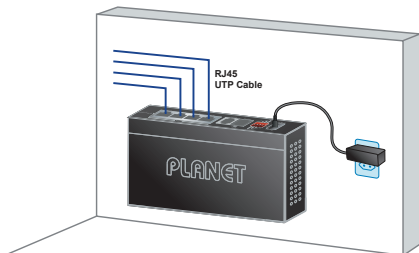

## ■ Chassis Installation and Rack Mounting (VC-231G)

To install the Ethernet over VDSL2 Converter in a **10-inch** or **19-inch** Converter Chassis with standard rack, follow the instructions described below.

**Step 1:** Place your VC-231G on a hard flat surface, with the front panel positioned towards your front side.

**Step 2:** Carefully slide in the module until it is fully and firmly fitted into the slot of the converter chassis.

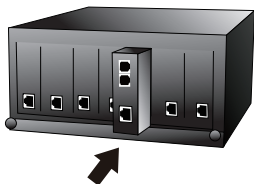

Insert a VDSL2 converter into an available slot

**Step 3:** Attach a rack-mount bracket to each side of the Converter Chassis with supplied screws attached to the package.

**Step 4:** After the brackets are attached to the Converter Chassis, use suitable screws to securely attach the brackets to the rack.

**Step 5:** Connect one end of the power cable to the **10-inch** or **19-inch** Converter Chassis.

**Step 6:** Connect the power plug of the power cable to a standard wall outlet, and then power on the **10-inch** or **19-inch** Converter Chassis. The PWR LED should be lit.



Note

Please refer to your User's Manual for setting up the device.