

**8/16/24-Port 10/100/1000T 802.3at PoE  
+ 2-Port Gigabit TP/SFP Ethernet Switch**

**GSD-1002VHP/GSW-1820VHP/GSW-2620VHP**

User's Manual

## **Trademarks**

Copyright © PLANET Technology Corp. 2016.

Contents are subject to revision without prior notice.

PLANET is a registered trademark of PLANET Technology Corp. All other trademarks belong to their respective owners.

## **Disclaimer**

PLANET Technology does not warrant that the hardware will work properly in all environments and applications, and makes no representation, either implied or expressed, with respect to the quality, performance, merchantability, or fitness for a particular purpose.

PLANET has made every effort to ensure that this User's Manual is accurate; PLANET disclaims liability for any inaccuracies or omissions that may have occurred.

Information in this User's Manual is subject to change without notice and does not represent a commitment on the part of PLANET. PLANET assumes no responsibility for any inaccuracies that may be contained in this User's Manual. PLANET makes no commitment to update or keep current the information in this User's Manual, and reserves the right to make improvements to this User's Manual and/or to the products described in this User's Manual, at any time without notice.

If you find information in this manual that is incorrect, misleading, or incomplete, we would appreciate your comments and suggestions.

## **FCC Warning**

This equipment has been tested and found to comply with the limits for a Class A digital device, pursuant to Part 15 of the FCC Rules. These limits are designed to provide reasonable protection against harmful interference when the equipment is operated in a commercial environment. This equipment generates, uses, and can radiate radio frequency energy and, if not installed and used in accordance with the Instruction manual, may cause harmful interference to radio communications. Operation of this equipment in a residential area is likely to cause harmful interference in which case the user will be required to correct the interference at his own expense.

## **CE Mark Warning**

This is a Class A product. In a domestic environment, this product may cause radio interference, in which case the user may be required to take adequate measures.

## **Energy Saving Note of the Device**

This power required device does not support Standby mode operation. For energy saving, please remove the power cable to disconnect the device from the power circuit. Without removing power cable, the device will still consume power from the power source. In view of Saving the Energy and reducing the unnecessary power consumption, it is strongly suggested to remove the power connection from the device if this device is not intended to be active.

## **WEEE Warning**



To avoid the potential effects on the environment and human health as a result of the presence of hazardous substances in electrical and electronic equipment, end users of electrical and electronic equipment should understand the meaning of the crossed-out wheeled bin symbol. Do not dispose of WEEE as unsorted municipal waste and have to collect such WEEE separately.

## **Revision**

PLANET 8/16/24-Port 10/100/1000T 802.3at PoE+ 2-Port Gigabit TP/SFP Ethernet Switch User's Manual

Models: GSD-1002VHP, GSW-1820VHP, GSW-2620VHP

Revision: 0.9 (June, 2016)

Part No.: 2351-AK3240-000

# Table of Contents

1. Introduction .....	5
1.1 Package Contents .....	5
1.2 Product Description.....	6
1.3 Features .....	8
1.4 Specifications .....	10
2. Hardware Description .....	12
2.1 Front Panel .....	12
2.1.1 LCD Monitor Indicators .....	15
2.1.2 LED Indicators .....	17
2.2 Rear Panel .....	18
3. Hardware Installation .....	19
3.1 Desktop Installation .....	20
3.2 Rack Mounting .....	21
3.3 Installing the SFP Transceiver .....	22
3.4 Product Applications.....	25
3.5 Power over Ethernet Powered Devices .....	26
4. Power over Ethernet Overview .....	27
5. Troubleshooting .....	30
Appendix A Networking Connection .....	31
A.1 Switch's Data RJ45 Pin Assignments - 1000Mbps, 1000BASE-T .....	31
A.2 10/100Mbps, 10/100BASE-TX .....	31

# 1. Introduction





Thank you for purchasing PLANET 8/16/24-Port 10/100/1000T 802.3at PoE+ 2-Port Gigabit TP/SFP Ethernet Switch series, GSD-1002VHP, GSW-1820VHP and GSW-2620VHP. The descriptions of these models are shown below:

- GSD-1002VHP 8-Port 10/100/1000T 802.3at PoE + 2-Port 10/100/1000T Desktop Switch
- GSW-1820VHP 16-Port 10/100/1000T 802.3at PoE + 2-Port Gigabit SFP Ethernet Switch
- GSW-2620VHP 24-Port 10/100/1000T 802.3at PoE + 2-Port Gigabit SFP Ethernet Switch

“802.3at PoE+ Switch” is used as an alternative name in this user’s manual.

## 1.1 Package Contents

Open the box of the 802.3at PoE+ Switch and carefully unpack it. The box should contain the following items:

802.3at PoE+ Switch x 1	User’s Manual x 1
	
Power Cord x 1	Accessories x 1
	

If any of these pieces are missing or damaged, please contact your dealer immediately; if possible, retain the carton including the original packing material, and use them again to repack the product in case there is a need to return it to us for repair.

## 1.2 Product Description

### Ideal High-performance Integration Solution for Secure IP Surveillance Infrastructure

Particularly designed for the growing popular IP surveillance applications, PLANET GSD/GSW 802.3at PoE+ Switch series is positioned as a surveillance switch with the central power management and IP camera monitoring.

The GSD/GSW 802.3at PoE+ Switch series brings an ideal, secure surveillance system at a lower total cost. The GSD/GSW 802.3at PoE+ Switch series provides multiple 10/100/1000 Mbps 802.3at/af PoE ports able to feed sufficient PoE power for IEEE 802.3at PoE IP cameras at the same time. It is also able to be connected with an 8/16/32-channel NVR system, uplinked to the backbone switch and the monitoring center. With such a high-performance switch architecture, the recorded video files from the PoE IP cameras can be saved in the NVR system to enable the administrators to control and monitor the surveillance images both in the local LAN and the remote sites.

Model	GSD-1002VHP	GSW-1820VHP	GSW-2620VHP
10/100/1000T Copper	8 x RJ45	16 x RJ45	24 x RJ45
10/100/1000T Copper	2 x RJ45	-	-
1000X Fiber Optic	-	2 x SFP Slots	2 x SFP Slots
802.3at/af PoE+ Ports	8	16	24
PoE Budget	120 watts	300 watts	300 watts
Enclosure	12" metal case	19" metal case	19" metal case

### Centralized Power Management for Security and Public Service PoE Applications

To fulfill the needs of the high power consumption of PoE network applications, the GSD/GSW 802.3at PoE+ Switch series features the standard IEEE 802.3at Power over Ethernet Plus (PoE+) that combines up to 30 watts of power output and data per port over one Cat5E/6 Ethernet cable. It is designed specifically to meet the demand of the high power consumption of network PDs (powered devices) such as IR, PTZ, speed dome cameras and even box-type IP cameras with built-in fan and heater. Compliant with both 802.3at and 802.3af standards, the GSD/GSW 802.3at PoE+ Switch series allows more flexibility in power requirement for a variety of PDs, making installation costs affordable.

### LCD Monitor for Real-time PoE Usage and System Status Display

The LCD monitor of the GSD/GSW 802.3at PoE+ Switch series clearly shows the levels of PoE power usage and system status, such as overload, low voltage, over voltage and high temperature. With its brand-new LCD monitor, user is able to

obtain detailed information about real-time PoE power usage and real-time system status of the GSD/GSW 802.3at PoE+ Switch series.

**PoE Port Status**

PoE Port Status	
P01: 11.4W	P05: 11.4W
P02: 11.4W	P06: -----
P03: ULP	P07: 21.4W
P04: OLP	P08: SCP
PB: 300W	TP: 109W-8

**Power Over-voltage Protection**

WARNING!

Main supply voltage is high!

All ports are shut down.

**Power Low-voltage Protection**

WARNING!

Main supply voltage is low!

All ports are shut down.

**Power Over Temperature Protection**

WARNING!

The PSE device is too hot!

All ports are shut down.

### Easy Installation and Cable Connection

As data transfer and High Power PoE are transmitted over a cable, the GSD/GSW 802.3at PoE+ Switch series is able to reduce the need of extended cables and electrical outlets on the wall, ceiling or any unreachable place. It helps to lower the installation costs and simplify the installation effort. All RJ45 copper interfaces of the GSD/GSW 802.3at PoE+ Switch series support 10/100Mbps and 10/100/1000Mbps auto-negotiation for optimal speed detection through RJ45 Category 6, 5 or 5e cable. It also supports standard auto-MDI/MDI-X that can detect the type of connection to any Ethernet device without requiring special straight-through or crossover cables.

### Flexible and Extendable Uplink Solution

The GSD/GSW 802.3at PoE+ Switch series provides 2 extra Gigabit TP or SFP ports supporting 10/100/1000BASE-T RJ45 copper for surveillance network devices such as NVR, video streaming server or NAS to facilitate surveillance management. Or through these Gigabit speed fiber SFP slots, the 1000BASE-SX/LX SFP (Small Form-factor Pluggable) fiber transceiver is inserted to be uplinked to a backbone switch and monitoring center over a long distance. The distance can be extended from 550m to 2km (multi-mode fiber), even going up to above 10/20/30/40/50/60/70/120km (single-mode fiber or WDM fiber). They are well suited for applications within the enterprise data centers and distributions.

## 1.3 Features

### Physical Port

- GSD-1002VHP
  - 8-port 10/100/1000BASE-T Gigabit RJ45 copper
  - 2-port 10/100/1000BASE-T Gigabit RJ45 copper
- GSW-1820VHP
  - 16-port 10/100/1000BASE-T Gigabit RJ45 copper
  - 2 1000BASE-X mini-GBIC SFP interfaces
- GSW-2620VHP
  - 24-port 10/100/1000BASE-T Gigabit RJ45 copper
  - 2 1000BASE-X mini-GBIC SFP interfaces

### Power over Ethernet

- Complies with IEEE 802.3af/at Power over Ethernet end-span PSE
- Up to 8/16/24 ports of IEEE 802.3af/802.3at devices powered
- Supports PoE Power up to 30.8 watts for each PoE port
- Each port supports 51V DC power to PoE Powered Device (GSD-1002VHP)
- 120-watt PoE budget (GSD-1002VHP)
- Each port supports 54V DC power to PoE Powered Device (GSW-1820VHP or GSW-2620VHP)
- 300-watt PoE budget (GSW-1820VHP or GSW-2620VHP)
- Auto detects powered device (PD)
- Circuit protection prevents power interference between ports
- Remote power feeding up to 100m with standard mode

### Switching

- Hardware based 10/100/1000Mbps auto-negotiation and auto MDI/MDI-X
- Flow control for full duplex operation and back pressure for half duplex operation
- Integrates address look-up engine, supporting 8K absolute MAC addresses
- IEEE 802.1Q VLAN transparency



- 
- Hardware DIP switch for **“Standard”**, **“VLAN”** and **“Extend”** mode selection; the **“Extend”** mode features 30-watt PoE transmit distance of 250m at speed of 10Mbps and VLAN isolation
  - Solid DIP switch to isolate ports to prevent broadcast storm and defend DHCP spoofing
  - Automatic address learning and address aging

## Hardware

- 12/19-inch desktop size, 1U height, rack mountable
- LED indicators for system power, per port PoE ready and PoE activity, speed, Link/Act
- LCD Monitor for system status and PoE usage status display
- 1 silent fan to provide stable and efficient power performance (GSD-1002VHP)
- 2 silent fans to provide stable and efficient power performance (GSW-1820VHP or GSW-2620VHP)

## 1.4 Specifications

Model		GSD-1002VHP	GSW-1820VHP	GSW-2620VHP
Hardware Specifications				
802.3af/802.3at PoE Injector Port		8	16	24
10/100BASE-TX MDI/MDIX Ports		8	16	24
10/100/1000BASE-T MDI/MDIX Ports		2	-	
1000BASE-X SFP/mini-GBIC Slots		-	2	
DIP Switch		1		
Switch Architecture		Store-and-Forward		
Switch Fabric		20Gbps/ non-blocking	36Gbps/ non-blocking	52Gbps/ non-blocking
Switch Throughput@64 bytes		14.9Mpps@64 bytes	26.8Mpps@64 bytes	38.7Mpps@64 bytes
MAC Address Table		8K entries		
Maximum Frame Size		9216 bytes		
Flow Control		IEEE 802.3x pause frame for full-duplex; back pressure for half-duplex		
LED	System	Power (Green)		
	10/100/1000BASE-T RJ45 Interfaces	10/100Mbps LNK/ACT (Orange) 1000Mbps LNK/ACT (Green) PoE-in-Use (Orange)		
	1000BASE-X SFP Interfaces	-	LNK/ACT (Green) 1000Mbps LNK/ACT (Green)	
LCD Monitor (W x D)		39.5mm x 24.8mm System Status/PoE Usage Port Status		
Dimensions (W x D x H)		180 x 280 x 44 mm (1U height)	233 x 440 x 44 mm (1U height)	
Enclosure		Metal		
Weight		1.8kg	3.3kg	3.4kg

Power Requirements	AC 100~240V, 50/60Hz, 2.5A max.	100~240V AC, 50/60Hz, 5A max.	
Power Consumption/ Dissipation	Max. 130 watts/446 BTU	Max. 330 watts/1132 BTU	
Thermal Fan	1	2	
Power over Ethernet			
PoE Standard	IEEE 802.3af Power over Ethernet/PSE IEEE 802.3at Power over Ethernet Plus/PSE		
PoE Power Supply Type	End-span		
PoE Power Output	Per port 53V-54V DC, 300mA. max. 15.4 watts (IEEE 802.3af) Per port 53V-54V DC, 600mA. max. 30 watts (IEEE 802.3at)		
Power Pin Assignment	1/2 (+), 3/6 (-)		
PoE Power Budget	120 watts	300 watts	
Max. Number of Class 2 PDs	8	16	24
Max. Number of Class 3 PDs	8	16	23
Max. Number of Class 4 PDs	4	11	11
Standards Conformance			
Regulatory Compliance	FCC Part 15 Class A, CE		
Standards Compliance	IEEE 802.3 10BASE-T IEEE 802.3u 100BASE-TX IEEE 802.3ab Gigabit 1000BASE-T IEEE 802.3z Gigabit SX/LX IEEE 802.3x Flow control and back pressure IEEE 802.3af Power over Ethernet IEEE 802.3at Power over Ethernet Plus		
Environment			
Operating	Temperature: 0 ~ 50 degrees C Relative Humidity: 5 ~ 95% (non-condensing)		
Storage	Temperature: -10 ~ 70 degrees C Relative Humidity: 5 ~ 95% (non-condensing)		

## 2. Hardware Description

These switches provide three different running speeds – 10Mbps, 100Mbps and 1000Mbps and automatically distinguish the speed of the incoming connection.

This section describes the hardware features of 802.3at PoE+ Switch. For easier management and control of the 802.3at PoE+ Switch, familiarize yourself with its display indicators and ports. Front panel illustrations in this chapter display the unit LED indicators. Before connecting any network device to the 802.3at PoE+ Switch, please read this chapter carefully.

### 2.1 Front Panel

The Front Panel of the 802.3at PoE+ Switch consists of 8/16/24 802.3af/802.3at auto-sensing 10/100/1000Mbps Ethernet RJ45 ports and 2 Gigabit TP/SFP ports . The LCD monitor and LED Indicators are also located on the front panel of the 802.3at PoE+ Switch.

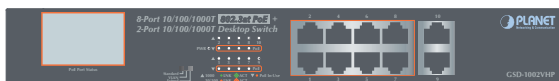

Figure 2-1: GSD-1002VHP Switch Front Panel



Figure 2-2: GSW-1820VHP Switch Front Panel



Figure 2-3: GSW-2620VHP Switch Front Panel

#### ■ Gigabit TP Interface

10/100/1000BASE-T copper, RJ45 twisted-pair: Up to 100 meters.

#### ■ Gigabit SFP Slots

1000BASE-SX/LX mini-GBIC slot, SFP (Small Factor Pluggable) transceiver module: From 550 meters (multi-mode fiber) to 10/20/30/40/50/60/70/120 kilometers (single-mode fiber).

## ■ DIP Switch

The DIP switch that is located on the front panel of the GSD-1002VHP, GSW-1820VHP, GSW-2620VHP 802.3at PoE+ Switch provides “**Standard**”, “**VLAN**” and “**Extend**” mode selection; the “**Extend**” mode features 30-watt PoE transmit distance of 250m at speed of 10Mbps.

Model	GSD-1002VHP	GSW-1820VHP	GSW-2620VHP
DIP Switch Mode	Function		
Standard (default)	This mode makes the <b>802.3at PoE+ Switch</b> operate as a general switch and all PoE ports operate at 10/100/1000Mbps auto-negotiation.		
VLAN	<p>This mode makes the GSD-1002VHP operate as a <b>VLAN isolation</b> switch and</p> <ol style="list-style-type: none"> <li>1. Port 1 to port 8 will isolate respectively.</li> <li>2. Port 1 to port 8 can only communicate with port 9 and port 10 (uplink port).</li> </ol>	<p>This mode makes the GSW-1820VHP operate as a <b>VLAN isolation</b> switch and</p> <ol style="list-style-type: none"> <li>1. Port 1 to port 16/24 will isolate respectively.</li> <li>2. Port 1 to port 16 can only communicate with port 17 and port 18 (uplink port).</li> </ol>	<p>This mode makes the GSW-2620VHP operate as a <b>VLAN isolation</b> switch and</p> <ol style="list-style-type: none"> <li>1. Port 1 to port 24 will isolate respectively.</li> <li>2. Port 1 to port 24 can only communicate with port 25 and port 26 (uplink port).</li> </ol>
Extend With VLAN	<p>This mode makes the GSD-1002VHP operate as a <b>VLAN isolation</b> switch and</p> <ol style="list-style-type: none"> <li>1. Port 1 to port 8 will isolate respectively.</li> <li>2. Port 1 to port 8 can only communicate with port 9 and port 10 (uplink port).</li> <li>3. 30-watt PoE transmit distance of 250m at speed of 10Mbps.</li> </ol>	<p>This mode makes the GSW-1820VHP operate as a <b>VLAN isolation</b> switch and</p> <ol style="list-style-type: none"> <li>1. Port 1 to port 16 will isolate respectively.</li> <li>2. Port 1 to port 16 can only communicate with port 17 and port 18 (uplink port).</li> <li>3. 30-watt PoE transmit distance of 250m at speed of 10Mbps.</li> </ol>	<p>This mode makes the GSW-2620VHP operate as a <b>VLAN isolation</b> switch and</p> <ol style="list-style-type: none"> <li>1. Port 1 to port 24 will isolate respectively.</li> <li>2. Port 1 to port 24 can only communicate with port 25 and port 26 (uplink port).</li> <li>3. 30-watt PoE transmit distance of 250m at speed of 10Mbps.</li> </ol>

**Table 2-1:** GSD/GSW 802.3at PoE+ Switch DIP Switch Description

## Default PoE Mode

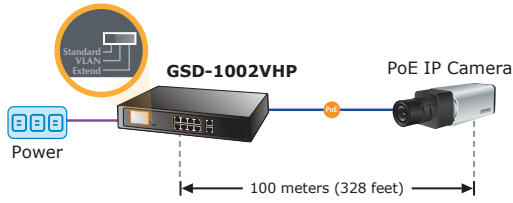

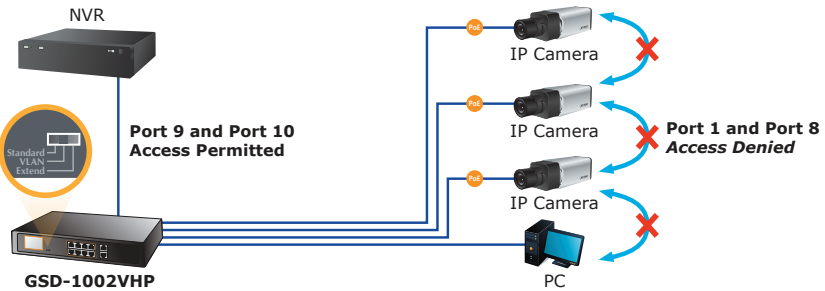

## VLAN Isolation Mode

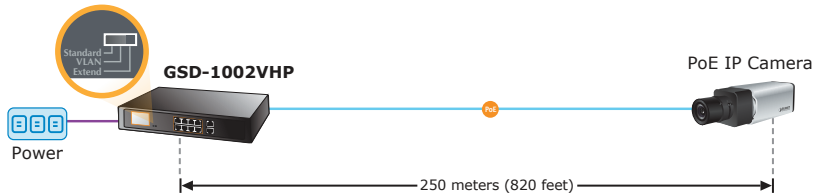

## Extended PoE Mode



-  10BASE-T UTP with PoE
-  1000BASE-T UTP
-  1000BASE-T UTP with PoE

## VLAN Isolation Feature

The 802.3at PoE+ Switch has one feature called VLAN function. When switching the DIP to the "VLAN" position, port 1 to port 8/16/24 wouldn't able to communicate with each other.

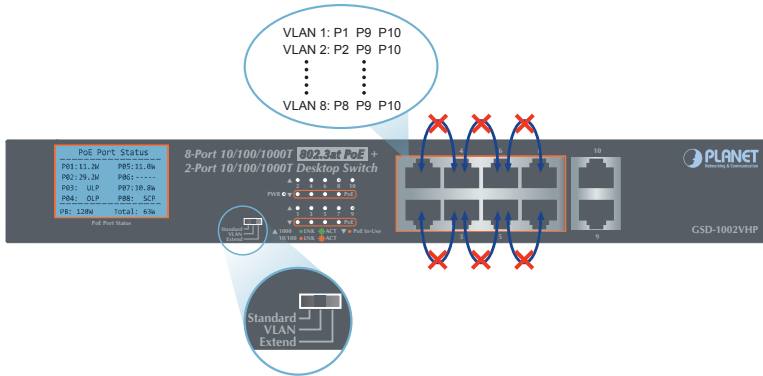

### 2.1.1 LCD Monitor Indicators

The 802.3at PoE+ Switch has a brand-new LCD monitor designed for network administrator who can easily obtain real-time per PoE port output watts information and system status display, such as over voltage, low voltage, and PoE chipset over temperature function. The details of each message on the LCD monitor are shown below:

GSD-1002VHP LCD Display

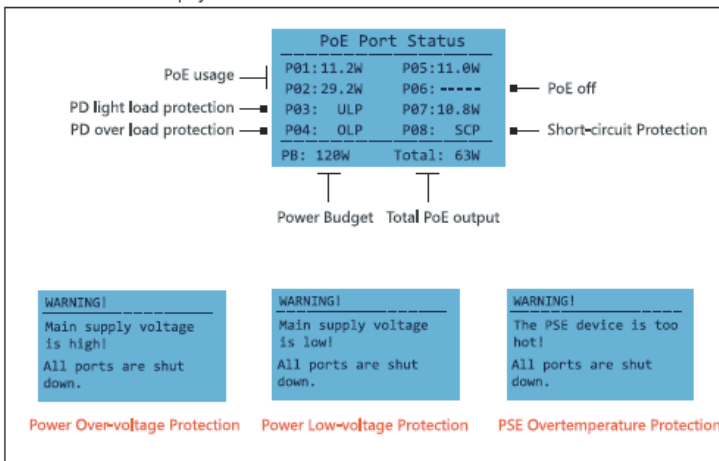

GSW-1820VHP LCD Display

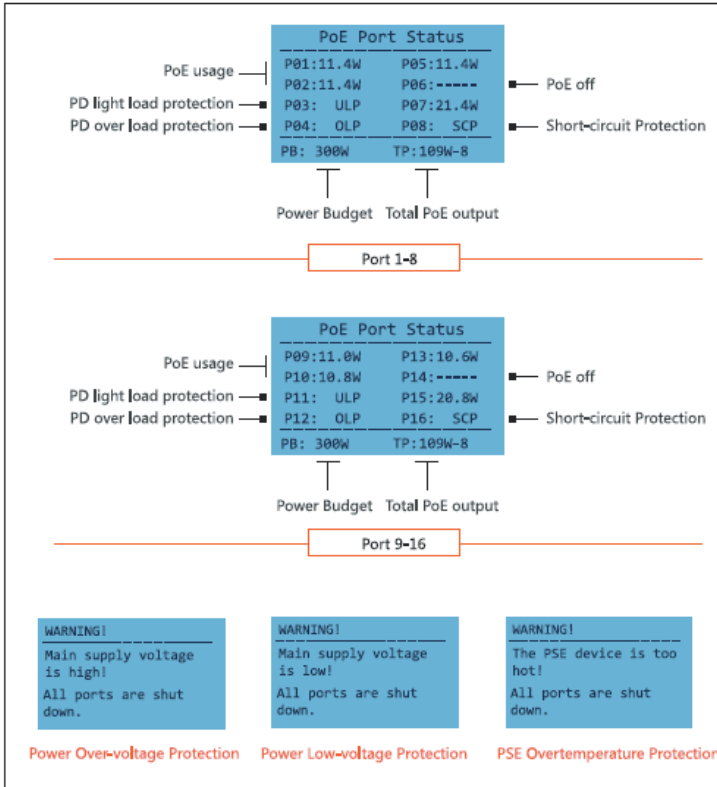

Note

1. The LCD Monitor screens of GSW-1820VHP and GSW-2620VHP are the same, except the port numbers and port allocation.
2. The LCD Monitor screens of GSW-1820VHP and GSW-2620VHP will refresh every 10 seconds.

The detailed description of each item is shown below:

**OLP:** It means Over Load Protect.

**ULP:** It means Under Load Protect.

**SCP:** It means Short Circuit Protect.

**C-E:** It means PD device classification error.

**PB:** It means Power Budget.

**Total:** It means total PoE power output information.



## 2.1.2 LED Indicators

### ■ System

LED	Color	Function
PWR	Green	Lights to indicate that the Switch has power.

### ■ Per 10/100/1000Mbps Port with PoE Interfaces

LED	Color	Function	
LNK/ACT	Orange	<b>Lights:</b>	Indicates the link through that port is successfully established at 10/100Mbps.
		<b>Blinks:</b>	Indicates that the Switch is actively sending or receiving data over that port.
LNK/ACT	Green	<b>Lights:</b>	Indicates the link through that port is successfully established at 1000Mbps.
		<b>Blinks:</b>	Indicates that the Switch is actively sending or receiving data over that port.
PoE In-Use	Orange	<b>Lights:</b>	Indicates the port is providing 53V DC in-line power.
		<b>Off:</b>	Indicates the connected device is not a PoE Powered Device (PD).

### ■ Per 1000Mbps SFP Slot

LED	Color	Function	
LNK/ACT	Green	<b>Lights</b>	Indicates that the Switch is actively sending or receiving data over that port.
1000	Green	<b>Lights</b>	Indicates the port is successfully established at 1000Mbps.

## 2.2 Rear Panel

The rear panel of the 802.3at PoE+ Switch indicates an AC power socket, which accepts input power from 100 to 240V AC, 50-60Hz, 2.5A/5A.



**Figure 2-4:** GSD-1002VHP Switch Rear Panel



**Figure 2-5:** GSW-1820VHP/GSW-2620VHP Switch Rear Panel

### ■ AC Power Receptacle

For compatibility with electrical outlet standard in most areas of the world, the 802.3at PoE+ Switch's power supply automatically adjusts to line power in the range of 100-240V AC and 50/60Hz, 2.5A/5A.

Plug the female end of the power cord firmly into the receptacle on the rear panel of the 802.3at PoE+ Switch and the other end into an electrical outlet and the power will be ready.



#### Power Notice

The device is a power-required device, which means it will not work till it is powered. If your networks should be active all the time, please consider using UPS (Uninterrupted Power Supply) for your device. It will prevent you from network data loss or network downtime. In some areas, installing a surge suppression device may also help to protect your 802.3at PoE+ Switch from being damaged by unregulated surge or current to the Switch or the power adapter.

### 3. Hardware Installation

#### Start up

Please refer to the following for your cabling:

#### 10/100/1000BASE-T

All 10/100/1000BASE-T ports come with Auto-Negotiation capability. They automatically support 1000BASE-T, 100BASE-TX and 10BASE-T networks. Users only need to plug a working network device into one of the 10/100/1000BASE-T ports, and then turn on the 802.3at PoE+ Switch. The port will automatically run in 10Mbps, 20Mbps, 100Mbps or 200Mbps and 1000Mbps or 2000Mbps after the negotiation with the connected device.

#### Cabling

Each 10/100BASE-TX ports and 10/100/1000BASE-T port uses RJ45 sockets -- similar to phone jacks -- for connection of unshielded twisted-pair cable (UTP). The IEEE 802.3/802.3u/802.3ab Fast/Gigabit Ethernet standard requires Category 5 UTP for 100Mbps 100BASE-TX. 10BASE-T networks can use Cat.3, 4, 5 or 1000BASE-T uses 5/5e/6 UTP (see table below). Maximum distance is 100 meters (328 feet).

Port Type	Cable Type	Connector
10BASE-T	Cat.3, 4, 5, 2-pair	RJ45
100BASE-TX	Cat.5, 5e UTP, 4-pair	RJ45
1000BASE-T	Cat.5/5e/6 UTP, 4-pair	RJ45

Any Ethernet devices like hubs/PCs can connect to the 802.3at PoE+ Switch by using straight-through wires. The whole 10/100/1000Mbps ports are auto-MDI/MDI-X that can be used on straight-through or crossover cable.

## 3.1 Desktop Installation

To install the 802.3at PoE+ Switch on desktop, simply follow the following steps:

**Step 1:** Attach the rubber feet to the recessed areas on the bottom of the 802.3at PoE+ Ethernet Switch, as shown in Figure 3-1.

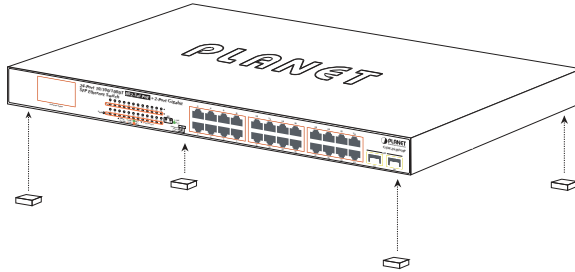

**Figure 3-1:** Attaching the Rubber Feet to the 802.3at PoE+ Switch

**Step 2:** Place the 802.3at PoE+ Switch on desktop near an AC power source.

**Step 3:** Keep enough ventilation space between the 802.3at PoE+ Switch and the surrounding objects.



### Note

When choosing a location, please keep in mind the environmental restrictions discussed in Chapter 1, Section 4, under Specifications.

**Step 4:** Connect your 802.3at PoE+ Switch to 802.3af/802.3at complied Power Devices (PD) and other network devices.

- A.** Connect one end of a standard network cable to the 10/100BASE-TX RJ45 ports on the front panel of the 802.3at PoE+ Switch.
- B.** Connect the other end of the cable to the network devices such as printer servers, workstations or routers, etc.



### Note

Connection to the Switch requires UTP Category 5, 5e, 6 network cabling with RJ45 tips. For more information, please see the Cabling Specification in Appendix A.

**Step 5:** Supply power to the 802.3at PoE+ Switch.

- A.** Connect one end of the power cable to the 802.3at PoE+ Switch.
- B.** Connect the power plug of the power cable to a standard wall outlet.

When the 802.3at PoE+ Switch receives power, the Power LED should remain solid Green.

## 3.2 Rack Mounting

To install the 802.3at PoE+ Switch in a 19-inch standard rack, follow the instructions described below.

**Step 1:** Place your 802.3at PoE+ Switch on a hard flat surface, with the front panel positioned towards your front side.

**Step 2:** Attach a rack-mount bracket to each side of the 802.3at PoE+ Switch with supplied screws attached to the package. Figure 3-2 shows how to attach brackets to one side of the 802.3at PoE+ Switch.

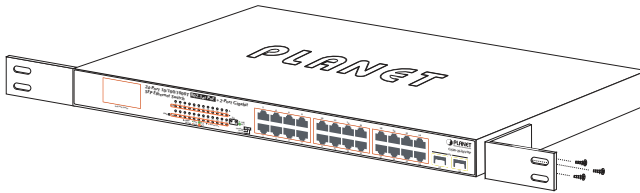

**Figure 3-2:** Attaching the Brackets to the 802.3at PoE+ Switch.



You must use the screws supplied with the mounting brackets. Damage caused to the parts by using incorrect screws would invalidate the warranty.

**Step 3:** Secure the brackets tightly.

**Step 4:** Follow the same steps to attach the second bracket to the opposite side.

**Step 5:** After the brackets are attached to the 802.3at PoE+ Switch, use suitable screws to securely attach the brackets to the rack, as shown in Figure 3-3.

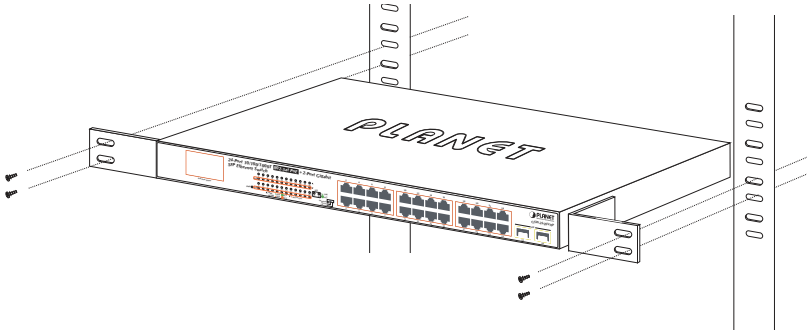

**Figure 3-3:** Mounting the 802.3at PoE+ Switch in a Rack

**Step 6:** Proceed with Steps 4 and 5 of **session 3.1 Desktop Installation** to connect the network cabling and supply power to your Switch.

### 3.3 Installing the SFP Transceiver

The sections describe how to insert an SFP transceiver into an SFP slot of the 802.3at PoE+ Switch.

The SFP transceivers are hot-pluggable and hot-swappable. You can plug in and out the transceiver to/from any SFP port without having to power down the 802.3at PoE+ Switch, as the Figure 3-4 shows.

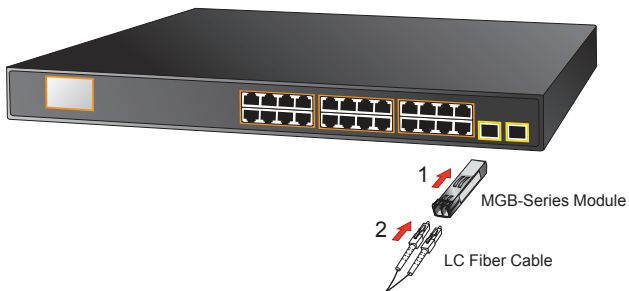

**Figure 3-4:** Plug In the SFP Transceiver

## ■ Approved PLANET SFP Transceivers

PLANET 802.3at PoE+ Switch supports both single mode and multi-mode SFP transceivers. The following list of approved PLANET SFP transceivers is correct at the time of publication:

### Gigabit SFP Transceiver Modules

■ MGB-GT	SFP-Port 1000BASE-T Module
■ MGB-SX	SFP-Port 1000BASE-SX mini-GBIC module - 550m
■ MGB-LX	SFP-Port 1000BASE-LX mini-GBIC module - 10km
■ MGB-L30	SFP-Port 1000BASE-LX mini-GBIC module - 30km
■ MGB-L50	SFP-Port 1000BASE-LX mini-GBIC module - 50km
■ MGB-L70	SFP-Port 1000BASE-LX mini-GBIC module - 70km
■ MGB-L120	SFP-Port 1000BASE-LX mini-GBIC module - 120km
■ MGB-LA10	SFP-Port 1000BASE-LX (WDM, TX:1310nm) - 10km
■ MGB-LB10	SFP-Port 1000BASE-LX (WDM, TX:1550nm) - 10km
■ MGB-LA20	SFP-Port 1000BASE-LX (WDM, TX:1310nm) - 20km
■ MGB-LB20	SFP-Port 1000BASE-LX (WDM, TX:1550nm) - 20km
■ MGB-LA40	SFP-Port 1000BASE-LX (WDM, TX:1310nm) - 40km
■ MGB-LB40	SFP-Port 1000BASE-LX (WDM, TX:1550nm) - 40km



#### Note

It is recommended to use PLANET SFP on the 802.3at PoE+ Switch. If you insert an SFP transceiver that is not supported, the 802.3at PoE+ Switch will not recognize it.

1. Before we connect the 802.3at PoE+ Switch to the other network device, we have to make sure both sides of the SFP transceivers are with the same media type, for example, 1000BASE-SX to 1000BASE-SX; 1000BASE-LX to 1000BASE-LX.
2. Check whether the fiber-optic cable type matches with the SFP transceiver requirement.
  - To connect to 1000BASE-SX SFP transceiver, please use the multi-mode fiber cable with one side being the male duplex LC connector type.
  - To connect to 1000BASE-LX SFP transceiver, please use the single-mode fiber cable with one side being the male duplex LC connector type.

## ■ Connect the Fiber Cable

1. Insert the duplex LC connector into the SFP transceiver.
2. Connect the other end of the cable to a device with SFP transceiver installed.
3. Check the LNK/ACT LED of the SFP slot on the front of the 802.3at PoE+ Switch. Ensure that the SFP transceiver is operating correctly.

## ■ Remove the Transceiver Module

1. Make sure there is no network activity anymore.
2. Remove the Fiber-Optic Cable gently.
3. Lift up the lever of the MGB module and turn it to a horizontal position.
4. Pull out the module gently through the lever, as the Figure 3-5 shows.

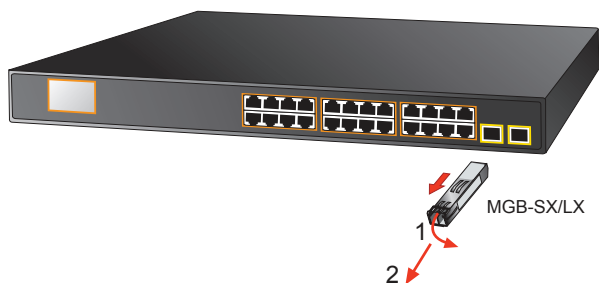

**Figure 3-5:** How to Pull Out the SFP Transceiver



### Note

Never pull out the module without lifting up the lever of the module and turning it to a horizontal position. Directly pulling out the module could damage the module and the SFP module slot of the 802.3at PoE+ Switch.



### 3.4 Product Applications

#### Department/Workgroup PoE Switch:

Providing 8/16/24 PoE in-line power interfaces, the 802.3at PoE+ Switch can easily build a power that centrally controls IP phone system, IP camera system and wireless AP group for enterprises. Cameras can be installed around the corner in the company or campus for surveillance demands. Without the power-socket limitation, the 802.3at PoE+ Switch makes the installation of cameras more easily and efficiently.

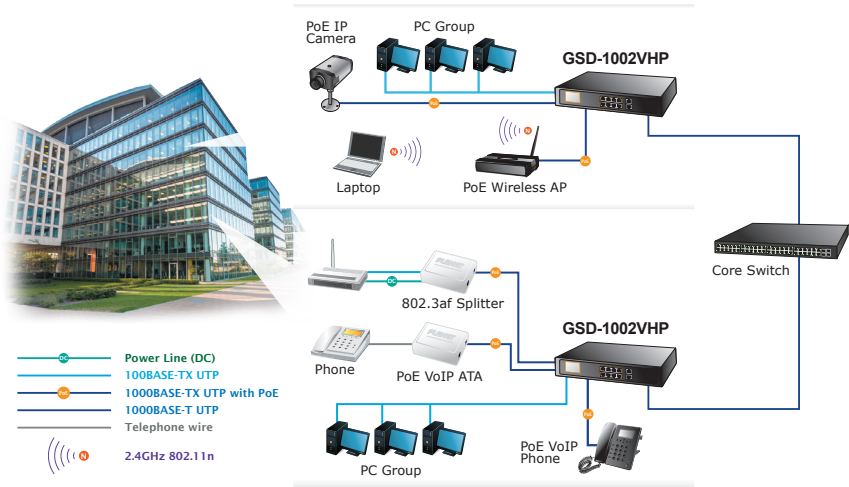







Figure 3-6: Department/Workgroup 802.3at PoE+ Switch Connection

### 3.5 Power over Ethernet Powered Devices

 <p><b>3~5 watts</b></p>	<p><b>Voice over IP Phones</b></p> <p>As many as PoE VoIP phones, ATAs and other Ethernet/non-Ethernet end-devices can be installed, but UPS is needed for uninterrupted power system and power control system.</p>
 <p><b>6~12 watts</b></p>	<p><b>Wireless LAN Access Points</b></p> <p>Access points can readily be installed in museums, sightseeing sites, airports, hotels, campuses, factories and warehouses.</p>
 <p><b>10~12 watts</b></p>	<p><b>IP Surveillance</b></p> <p>For the sake of security, install IP cameras around enterprises, museums, campuses, hospitals and bank without considering location and electrical outlets.</p>
 <p><b>3~12 watts</b></p>	<p><b>PoE Splitter</b></p> <p>As PoE Splitter splits the PoE 48V DC over the Ethernet cable into 5/12V DC power output, network deployments can easily be made without worrying about power outlet locations, thus eliminating the costs for additional AC wiring and reducing the installation time.</p>
 <p><b>3~25 watts</b></p>	<p><b>High Power PoE Splitter</b></p> <p>As PoE Splitter splits the PoE 53V-54V DC over the Ethernet cable into 24/12V DC power output, network deployments can easily be made without worrying about power outlet locations, thus eliminating the costs for additional AC wiring and reducing the installation time.</p>
 <p><b>30 watts</b></p>	<p><b>High Power Speed Dome</b></p> <p>This state-of-the-art design fits very nicely in various network environments like traffic centers, shopping malls, railway stations, warehouses, airports and production facilities for the most demanding outdoor surveillance applications. Electrician is not needed to install AC sockets.</p>



**Note**

Since each port of the 802.3at PoE+ Switch supports 53V-54 DC PoE power output, please make sure the Powered Device's (PD) acceptable DC power range is from 53V-54 DC. Otherwise, it will damage the Powered Device (PD).

---

## 4. Power over Ethernet Overview

### What is PoE?

PoE is an abbreviation of Power over Ethernet. The PoE technology means a system safely transmits both power and data on Ethernet UTP cable. The IEEE standard for PoE technology requires Category 5 cable or higher for high power PoE levels, but can operate with Cat3 cable for low power levels. Power is supplied in common mode over two or more of the differential pairs of wires found in the Ethernet cables and comes from a power supply within a PoE-enabled network device such as an Ethernet switch or can be injected into a cable run with a mid-span power supply.

The original IEEE 802.3af-2003 PoE standard provides up to 15.4W of DC power (minimum 44V DC and 350mA) to each device. Only 12.95W is assured to be available at the powered device as some power is dissipated in the cable.

The updated IEEE 802.3at-2009 PoE standard, also known as PoE+ or PoE plus, provides up to 25.5W of power. The 2009 standard prohibits a powered device from using all four pairs for power.

The 802.3af/802.3at define two types of source equipment: mid-span and end-span.

#### Mid-span

Mid-span device is placed between legacy switch and the powered device. Mid-span taps the unused wire pairs 4/5 and 7/8 to carry power; the other four are for data transmit.

#### End-span

End-span device is directly connected with power device. End-span could also tap the wire 1/2 and 3/6.

#### PoE System Architecture

The specification of PoE typically requires two devices: the **Powered Source Equipment (PSE)** and the **Powered Device (PD)**. The PSE is either an end-span or a mid-span, while the PD is a PoE-enabled terminal, such as IP phones, wireless LAN, etc. Power can be delivered over data pairs or spare pairs of standard Cat5 cabling.

#### Powered Source Equipment (PSE)

Power sourcing equipment (PSE) is a device such as a switch that provides (sources) power on the Ethernet cable. The maximum allowed for continuous output power per cable in IEEE 802.3af is 15.4W. A later specification, IEEE 802.3at, offers 25.50W. When the device is a switch, it is commonly called an end-span (although IEEE 802.3af refers to it as endpoint). Otherwise, if it is an

intermediary device between a non PoE capable switch and a PoE device, it is called a mid-span. An external PoE injector is a mid-span device.

### Powered Device

A powered device (PD) is a device powered by a PSE and thus consumes energy. Examples include wireless access points, IP phones, and IP cameras. Many powered devices have an auxiliary power connector for an optional, external power supply. Depending on the PD design, some, none, or all power can be supplied from the auxiliary port, with the auxiliary port sometimes acting as backup power in case of PoE supplied power failure.

### How Power is Transferred through Cable

A standard Cat5 Ethernet cable has four twisted pairs, but only two of these are used for 10BASE-T and 100BASE-TX. The specification allows two options for using these cables for power, shown in Figure 1 and Figure 2:

The spare pairs are used. Figure 1 shows the pair on pins 4 and 5 connected together and forming the positive supply, and the pair on pins 7 and 8 connected together and forming the negative supply. (In fact, a late change to the spec allows either polarity to be used).

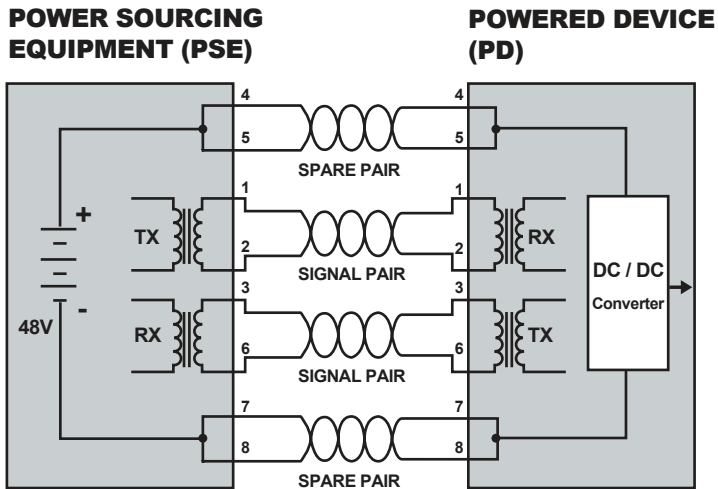

Figure 1: Power Supplied over Spare Pins

The data pairs are used. Since Ethernet pairs are transformers coupled at each end, it is possible to apply DC power to the center tap of the isolated transformer without upsetting the data transfer. In this mode of operation, the pair on pins 3 and 6 and the pair on pins 1 and 2 can be of either polarity.

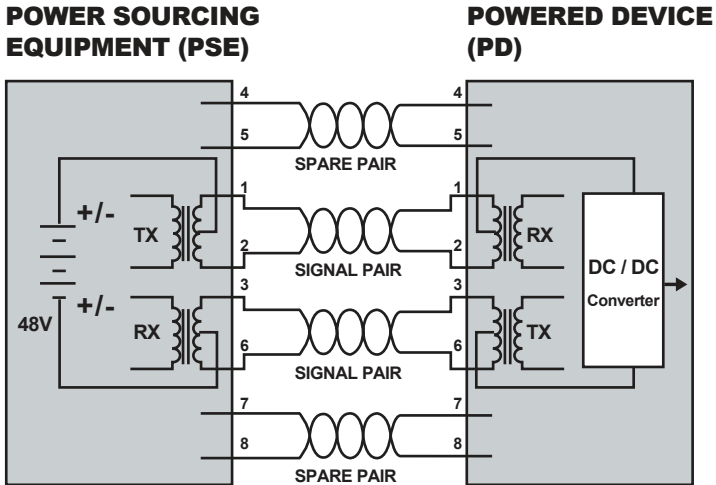

Figure 2: Power Supplied over the Data Pins

### When to install PoE

Consider the following scenarios:

- You're planning to install the latest VoIP phone system to minimize cabling building costs when your company moves into a new office next month.
- The company staff has been clamoring for a wireless access point in the picnic area behind the building so they can work on their laptops through lunch, but the cost of electrical power to the outside is not affordable.
- Management asks for IP Surveillance Cameras and business access systems throughout the facility, but they would rather avoid another electrician's payment.

## 5. Troubleshooting

This chapter contains information to help you solve issues. If the 802.3at PoE+ Switch is not functioning properly, make sure the 802.3at PoE+ Switch was set up according to instructions in this manual.

### **The Link LED is not lit.**

#### **Solution:**

Check the cable connection and also try to swap one new cable.

### **100BASE-T port link LED is lit, but the traffic is irregular.**

#### **Solution:**

Make sure the attached device is not set to full duplex. Some devices use a physical or software switch to change duplex modes. Auto-negotiation may not recognize this type of full-duplex setting.

### **Why the Switch doesn't connect to the network**

#### **Solution:**

Check the LNK/ACT LED on the 802.3at PoE+ Switch. Try another port on the 802.3at PoE+ Switch. Make sure the cable is installed properly. Make sure the cable is the right type. Turn off the power. After a while, turn on the power again.

### **Why the GSD-1002VHP/GSW-1820VHP/GSW-2620VHP, connected to PoE device, cannot be powered on**

#### **Solution:**

Please check the cable type of the connection from GSD-1002VHP/GSW-1820VHP/GSW-2620VHP to the other end. The cable should be an 8-wire UTP, Category 5 or above and EIA568 cable within 100 meters. A cable with only 4-wire, short loop or over 100 meters will affect the power supply.

Please make sure the device is fully complied with IEEE 802.3af/IEEE 802.3at standard.

### **What is the power output of each PoE port?**

#### **Solution:**

1. Each PoE port supports **53V-54 DC, 600mA** and a **maximum of 30 watts** of power output. Detect and inject by the standard of IEEE 802.3at.
2. Each PoE port supports **53V-54 DC, 300mA** and a **maximum of 15.4 watts** of power output. Detect and inject by the standard of IEEE 802.3af.

## Appendix A Networking Connection

### A.1 Switch's Data RJ45 Pin Assignments - 1000Mbps, 1000BASE-T

PIN NO	MDI	MDI-X
1	BI_DA+	BI_DB+
2	BI_DA-	BI_DB-
3	BI_DB+	BI_DA+
4	BI_DC+	BI_DD+
5	BI_DC-	BI_DD-
6	BI_DB-	BI_DA-
7	BI_DD+	BI_DC+
8	BI_DD-	BI_DC-

Implicit implementation of the crossover function within a twisted-pair cable, or at a wiring panel, while not expressly forbidden, is beyond the scope of this standard.

### A.2 10/100Mbps, 10/100BASE-TX

When connecting Switch to another Fast Ethernet switch, a straight-through or crossover cable might be necessary. Each port of the Switch supports auto-MDI/MDI-X detection, meaning you can directly connect the Switch to any Ethernet devices without making a crossover cable. The following table and diagram show the standard RJ45 receptacle/connector and their pin assignments:

RJ45 Connector pin assignment		
Contact	MDI Media Dependent Interface	MDI-X Media Dependent Interface-Cross
1	Tx + (transmit)	Rx + (receive)
2	Tx - (transmit)	Rx - (receive)
3	Rx + (receive)	Tx + (transmit)
4, 5	Not used	
6	Rx - (receive)	Tx - (transmit)
7, 8	Not used	

The standard cable, RJ45 pin assignment

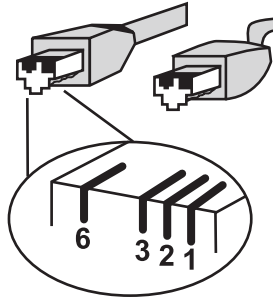

The standard RJ45 receptacle/connector

There are 8 wires on a standard UTP/STP cable and each wire is color-coded. The following shows the pin allocation and color of straight-through cable and crossover cable connection:

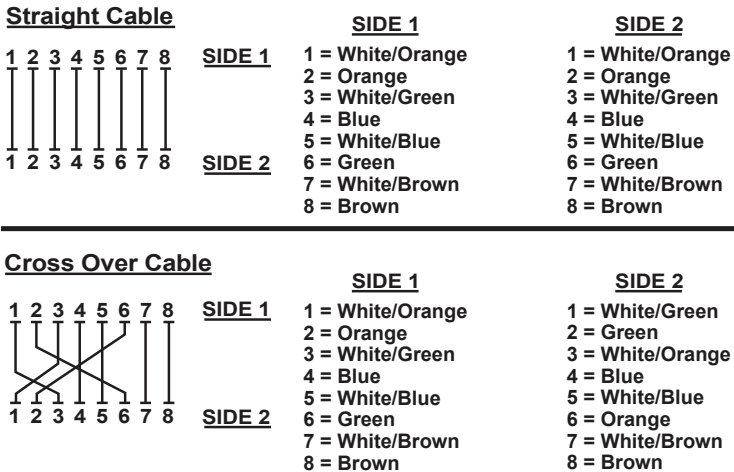

Figure A-1: Straight-through and Crossover Cable

Please make sure your connected cables are with the same pin assignment and color as the above picture before deploying the cables into your network.