

Industrial L2/L4 Managed Gigabit Switch

with 4/8-Port 802.3at PoE+

IGS-4215-4P4T/IGS-4215-4P4T2S/IGS-4215-8P2T2S

Quick Installation Guide

Table of Contents

1. Package Contents	3
2. Requirements	4
3. Wiring the Power Inputs.....	5
4. Terminal Setup	7
5. Logon to the Console.....	8
6. Configuring IP Address via the Console	9
7. Saving the Configuration via the Console.....	11
8. Starting Web Management	12
9. Saving Configuration via the Web	14
10. Recovering Back to Default Configuration	15
11. Customer Support.....	16

1. Package Contents

Thank you for purchasing PLANET L2/L4 Managed Gigabit Switch. The description of this model is shown below:

IGS-4215-4P4T

Industrial 4-Port 10/100/1000T 802.3at PoE + 4-Port 10/100/1000T Managed Switch

IGS-4215-4P4T2S

Industrial 4-Port 10/100/1000T 802.3at PoE + 4-Port 10/100/1000T + 2-Port 100/1000X SFP Managed Switch

IGS-4215-8P2T2S

Industrial 8-Port 10/100/1000T 802.3at PoE + 2-Port 10/100/1000T + 2-Port 100/1000X SFP Managed Switch

“**Industrial Managed PoE+ Switch**” is used as an alternative name in this Quick Installation Guide.

Open the box of the Industrial Managed PoE+ Switch and carefully unpack it. The box should contain the following items:

- The Industrial Managed PoE+ Switch x 1
- Quick Installation Guide x 1
- RS232 to RJ45 Console Cable x 1
- Dust Caps

Model	RJ45 Dust Caps	SFP Dust Caps
IGS-4215-4P4T	9	-
IGS-4215-4P4T2S	9	2
IGS-4215-8P2T2S	11	2

- DIN-rail Kit x 1
- Wall Mounting Kit x 1

If any item is found missing or damaged, please contact your local reseller for replacement.

2. Requirements

- ◆ Workstations running Windows XP/2003/Vista/7/8/10/2008, MAC OS X or later, Linux, UNIX, or other platforms are compatible with TCP/IP protocols.
- ◆ Workstations are installed with Ethernet NIC (Network Interface Card)
- ◆ Serial Port Connection (Terminal)
 - The above Workstations come with COM Port (DB9) or USB-to-RS232 converter.
 - The above Workstations have been installed with terminal emulator, such as Hyper Terminal included in Windows XP/2003.
 - Serial cable -- one end is attached to the RS232 serial port, while the other ends to the RJ45 console port of the Industrial Managed PoE+ Switch.
- ◆ Ethernet Port Connection
 - Network cables -- Use standard network (UTP) cables with RJ45 connectors.
 - The above PC is installed with Web browser and JAVA runtime environment plug-in.



Note

It is recommended to use Internet Explore 8.0 or above to access the Industrial Managed PoE+ Switch. If the Web interface of the Industrial Managed PoE+ Switch is not accessible, please turn off the anti-virus software or firewall and then try it again.

3. Wiring the Power Inputs

The Upper Panel of the Industrial Managed PoE+ Switch indicates a DC inlet power socket and consists of one terminal block connector within 6 contacts. Please follow the steps below to insert the power wire.

1. Insert positive/negative DC power wires into contacts 1 and 2 for Power 1 or 5, and 6 for Power 2.

IGS-4215-4P4T/IGS-4215-4P4T2S: DC 48~56V

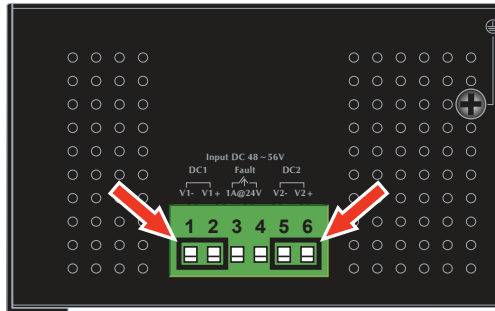

Figure 3-1: IGS-4215-4P4T/IGS-4215-4P4T2S DC Inlet Power Socket

IGS-4215-8P2T2S: DC 48~56V

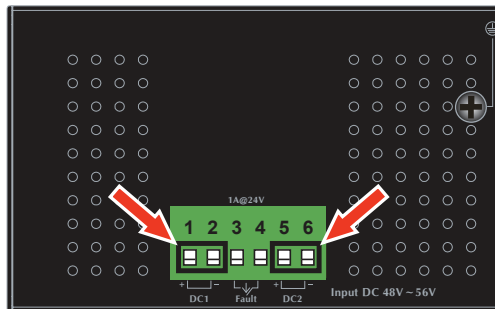
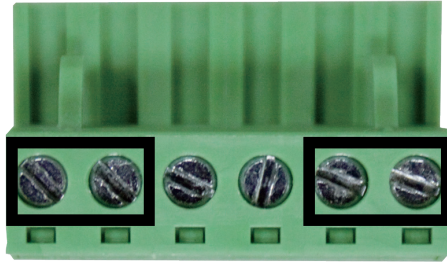

Figure 3-2: IGS-4215-8P2T2S DC Inlet Power Socket

2. Tighten the wire-clamp screws for preventing the wires from loosening.



1 2 3 4 5 6
 V1- V1+ V2- V2+
 Power 1 Power 2

Item	Negative (-) Pin	Positive (+) Pin
IGS-4215-4P4T/IGS-4215-4P4T2S	Pin 1/5	Pin 2/6

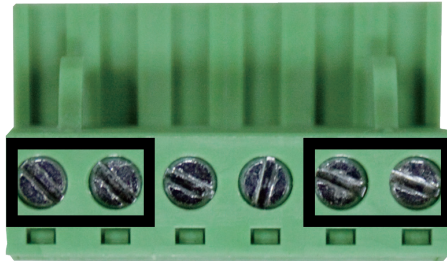

1 2 3 4 5 6
 V+ V- V+ V-
 Power 1 Power 2

Item	Positive (+) Pin	Negative (-) Pin
IGS-4215-8P2T2S	Pin 1/5	Pin 2/6



Note

The wire gauge for the terminal block should be in the range from **12** to **24 AWG**.

4. Terminal Setup

To configure the system, connect a serial cable to a **COM** port on a PC or notebook computer and to the RJ45 type of the console port of the Industrial Managed PoE+ Switch.

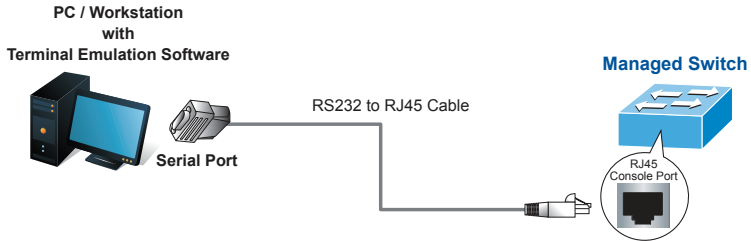

Figure 4-1: Industrial Managed PoE+ Switch Console Connectivity

A terminal program is required to make the software connection to the Industrial Managed PoE+ Switch.

1. Run terminal program on the OS.
2. When the following screen appears, make sure that the COM port should be configured as:

Baud:	115200
Data bits:	8
Parity:	None
Stop bits:	1
Flow control:	None

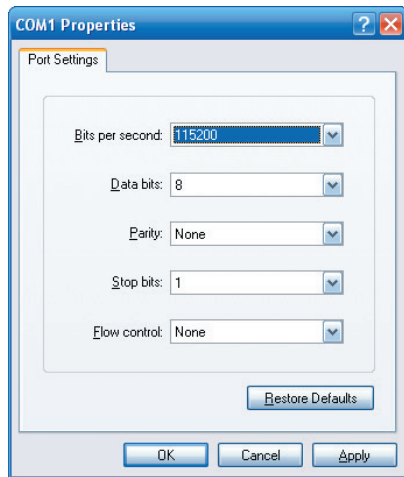

Figure 4-2: COM Port Configuration

5. Logon to the Console

Once the terminal is connected to the device, power on the Industrial Managed PoE+ Switch and the terminal will display "running testing procedures". Then, the following message asks to login user name and password. The factory default user name and password are shown as follows, and the login screen in Figure 5-1 appears.



Note

The following console screen is based on the IGS-4215-8P2T2S. The display of the IGS-4215-4P4T or IGS-4215-4P4T2S is the same as that of the IGS-4215-8P2T2S.

Username: **admin**

Password: **admin**

```
Press any key to continue
Username: admin
Password: *****
IGS-4215-8P2T2S#
```

Figure 5-1: Industrial Managed PoE+ Switch Console Login Screen

The user can now enter commands to manage the Industrial Managed PoE+ Switch. For a detailed description of the commands, please refer to the following chapters.



Note

1. For security reason, please change and memorize the new password after this first setup.
2. Only accept command in lowercase letter under console interface.

6. Configuring IP Address via the Console

The Industrial Managed PoE+ Switch is shipped with default IP address as follows:

```
IP Address: 192.168.0.100  
Subnet Mask: 255.255.255.0
```

To check the current IP address or modify a new IP address for the Industrial Managed PoE+ Switch, please use the procedures as follows:

■ Show the current IP address

1. At the "IGS-4215-8P2T2S#" prompt, enter "show ip".
2. The screen displays the current IP address, subnet mask and gateway as shown in Figure 6-1.

```
Press any key to continue  
Username: admin  
Password: *****  
IGS-4215-8P2T2S# show ip  
IP Address: 192.168.0.100  
Subnet Netmask: 255.255.255.0  
Default Gateway: 192.168.0.254  
IGS-4215-8P2T2S#
```

Figure 6-1: IP Information Screen

■ Configuring IP address

3. At the "IGS-4215-8P2T2S #" prompt, enter "configure".
4. At the "IGS-4215-8P2T2S (config)#" prompt, enter the following command and press <Enter> as shown in Figure 6-2.

```
IGS-4215-8P2T2S (config)# ip address 192.168.1.100 mask 255.255.255.0  
IGS-4215-8P2T2S (config)# ip default-gateway 192.168.1.254
```

The previous command would apply the following settings for the Industrial Managed PoE+ Switch.

```
IP Address: 192.168.1.100  
Subnet Mask: 255.255.255.0  
Gateway: 192.168.1.254
```

```
Press any key to continue
Username: admin
Password: ****
IGS-4215-8P2T2S# configure
IGS-4215-8P2T2S(config)# ip address 192.168.1.100 mask 255.255.255.0
IGS-4215-8P2T2S(config)# ip default-gateway 192.168.1.254
IGS-4215-8P2T2S(config)#
```

Figure 6-2: IP Address Screen

5. Repeat Step 1 to check if the IP address is changed.

If the IP is successfully configured, the Industrial Managed PoE+ Switch will apply the new IP address setting immediately. You can access the Web interface of the Industrial Managed PoE+ Switch through the new IP address.



Note

If you are not familiar with console command or the related parameter, enter "?" anytime in console to get the help description.

7. Saving the Configuration via the Console

In the Industrial Managed PoE+ Switch, the running configuration file is stored in the RAM. In the current version, the running configuration sequence of running-config can be saved from the RAM to FLASH by **copying** the **running-config startup-config** command, so that the running configuration sequence becomes the startup configuration file, which is called configuration save.

1. At the "IGS-4215-8P2T2S#" prompt, enter "copy running-config startup-config" as shown in Figure 7-1

```
Press any key to continue
Username: admin
Password: *****
IGS-4215-8P2T2S# copy running-config startup-config
Success
IGS-4215-8P2T2S#
```

Figure 7-1: The Configuration Save Screen

8. Starting Web Management

The following shows how to start up the **Web Management** of the Industrial Managed PoE+ Switch. Note the Industrial Managed PoE+ Switch is configured through an Ethernet connection. Please make sure the manager PC must be set to the same **IP subnet address**.

For example, the default IP address of the Industrial Managed PoE+ Switch is **192.168.0.100**, then the manager PC should be set to **192.168.0.x** (where x is a number between 1 and 254, except 100), and the default subnet mask is 255.255.255.0.

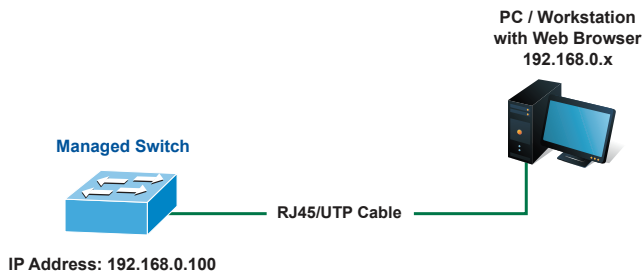

Figure 8-1: IP Management Diagram

■ Logging in to the Industrial Managed PoE+ Switch

1. Use Internet Explorer 8.0 or above Web browser and enter IP address **http://192.168.0.100** to access the Web interface.
2. When the following dialog box appears, please enter the default user name and password "**admin**". The login screen in Figure 8-2 appears.

Default Username: **admin**
Default Password: **admin**

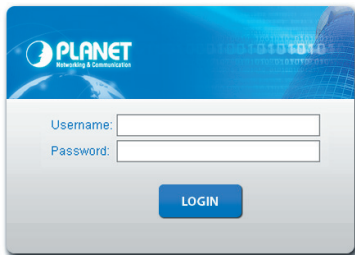
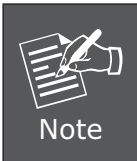

Figure 8-2: Web Login Screen

3. After entering the password, the main screen appears as Figure 8-3 shows.



The following web screen is based on the IGS-4215-8P2T2S. The display of the IGS-4215-4P4T or IGS-4215-4P4T2S is the same as that of the IGS-4215-8P2T2S.



Figure 8-3: Web Main Screen of Industrial Managed PoE+ Switch

The Switch Menu on the left of the Web page lets you access all the commands and statistics the Industrial Managed PoE+ Switch provides.

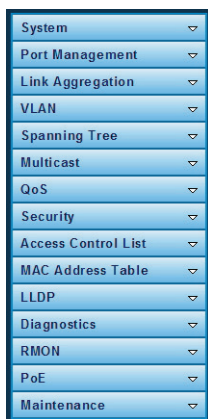

Figure 8-4: Switch Menu

Now, you can use the Web management interface to continue the Switch management. Please refer to the user's manual for more.

9. Saving Configuration via the Web

In the Industrial Managed PoE+ Switch, the running configuration file is stored in the RAM. In the current version, the running configuration sequence of running-config can be saved from the RAM to FLASH by **"Save Configurations to FLASH"** function, so that the running configuration sequence becomes the **startup configuration** file, which is called configuration save.

To save all applied changes and set the current configuration as a startup configuration, the startup-configuration file will be loaded automatically across a system reboot.

1. Click **"Save > Save Configurations to FLASH"** to log in to the "Configuration Manager" page.

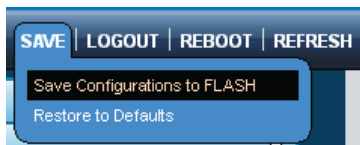

2. Press the **"Apply"** button to save running configuration to start up configuration.

Configuration Manager

Save Configuration

Source File	<input checked="" type="radio"/> Running configuration <input type="radio"/> Startup configuration <input type="radio"/> Backup configuration
Destination File	<input checked="" type="radio"/> Startup configuration <input type="radio"/> Backup configuration

10. Recovering Back to Default Configuration

- IP Address has been changed or admin password has been forgotten –

To reset the IP address to the default IP Address **“192.168.0.100”** or reset the login password to default value, press the hardware **reset button** on the front panel for about **10 seconds**. After the device is rebooted, you can log in the management Web interface within the same subnet of 192.168.0.xx.

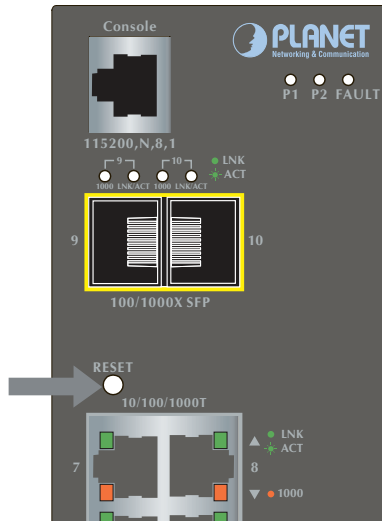

Figure 10-1: IGS-4215-4P4T/IGS-4215-4P4T2S Reset Button

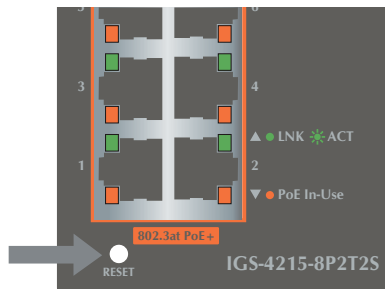

Figure 10-2: IGS-4215-8P2T2S Reset Button

11. Customer Support

Thank you for purchasing PLANET products. You can browse our online FAQ resource and User's Manual on PLANET Web site first to check if it could solve your issue. If you need more support information, please contact PLANET switch support team.

PLANET online FAQ:

<http://www.planet.com.tw/en/support/faq.php?type=1>

Switch support team mail address:

support_switch@planet.com.tw

IGS-4215-4P4T/IGS-4215-4P4T2S/IGS-4215-8P2T2S User's Manual:

<http://www.planet.com.tw/en/support/download.php?type1=22153&model=&type=3>



(Please select your switch model name from the Product Model drop-down menu)

Copyright © PLANET Technology Corp. 2017.

Contents are subject to revision without prior notice.

PLANET is a registered trademark of PLANET Technology Corp. All other trademarks belong to their respective owners.