

User's Manual

GT-902
GT-902S
GT-905A
GT-906A15 / GT-906B15
GT-906A60 / GT-906B60

10/100/1000Base-T to 1000Base-SX / LX
Managed Media Converter



Trademarks

Copyright © PLANET Technology Corp. 2008.

Contents subject to which revision without prior notice.

PLANET is a registered trademark of PLANET Technology Corp. All other trademarks belong to their respective owners.

Disclaimer

PLANET Technology does not warrant that the hardware will work properly in all environments and applications, and makes no warranty and representation, either implied or expressed, with respect to the quality, performance, merchantability, or fitness for a particular purpose.

PLANET has made every effort to ensure that this User's Manual is accurate; PLANET disclaims liability for any inaccuracies or omissions that may have occurred.

Information in this User's Manual is subject to change without notice and does not represent a commitment on the part of PLANET. PLANET assumes no responsibility for any inaccuracies that may be contained in this User's Manual. PLANET makes no commitment to update or keep current the information in this User's Manual, and reserves the right to make improvements to this User's Manual and/or to the products described in this User's Manual, at any time without notice.

If you find information in this manual that is incorrect, misleading, or incomplete, we would appreciate your comments and suggestions.

FCC Warning

This equipment has been tested and found to comply with the limits for a Class A digital device, pursuant to Part 15 of the FCC Rules. These limits are designed to provide reasonable protection against harmful interference when the equipment is operated in a commercial environment. This equipment generates, uses, and can radiate radio frequency energy and, if not installed and used in accordance with the Instruction manual, may cause harmful interference to radio communications. Operation of this equipment in a residential area is likely to cause harmful interference in which case the user will be required to correct the interference at whose own expense.

CE Mark Warning

This is a Class A product. In a domestic environment, this product may cause radio interference, in which case the user may be required to take adequate measures.

WEEE Warning



To avoid the potential effects on the environment and human health as a result of the presence of hazardous substances in electrical and electronic equipment, end users of electrical and electronic equipment should understand the meaning of the crossed-out wheeled bin symbol. Do not dispose of WEEE as unsorted municipal waste and have to collect such WEEE separately.

Revision

PLANET Managed Gigabit Ethernet Media Converter User's Manual

FOR MODELS: GT-902 / GT-902S / GT-905A / GT-906A15 / GT-906B15 / GT-906A60 / GT-906B60

REVISION: 1.0 (OCTOBER.2008)

Part No.: 2080-AA3450-002

TABLE OF CONTENTS

1. INTRODUCTION	1
1.1 PACKAGE CONTENTS	1
1.2 HOW TO USE THIS MANUAL	1
1.3 ABOUT THE MANAGED MEDIA CONVERTER.....	2
1.4 PRODUCT FEATURES	3
1.5 PRODUCT SPECIFICATION	4
2. HARDWARE DESCRIPTION.....	6
2.1 GT-90X FRONT PANEL	6
2.1.1 LED Indicators.....	7
2.1.2 GT-90X Rear Panel.....	7
2.2 INSTALL THE CONVERTER.....	8
2.2.1 Stand-alone Installation.....	8
2.2.2 Chassis Installation and Rack Mounting	10
3. MEDIA CONVERTER MANAGEMENT	12
3.1 OVERVIEW.....	12
3.2 MANAGEMENT METHODS.....	12
3.2.1 Web Management.....	13
3.2.2 SNMP Management.....	13
3.2.3 PLANET Smart Discovery Utility	14
3.2.4 Login the Managed Media Converter.....	15
4. WEB MANAGEMENT	16
4.1 MAIN MENU	16
4.2 SYSTEM	17
4.2.1 System Information	17
4.2.2 IP Configuration	18
4.2.3 Password Setting	19
4.2.4 Firmware Upgrade	20
4.2.5 SNMP Management.....	24
4.2.6 Factory Default.....	26
4.2.7 System Reboot.....	27
4.3 PORT MANAGEMENT	29
4.3.1 Port Configuration	29
4.3.2 Port Status.....	32
4.3.3 Port Statistics	33
4.4 CONVERTER CONFIGURATION	34
4.5 VLAN	35
4.5.1 VLAN Group.....	37
4.5.2 VLAN Per Port Setting	39

4.5.3 Q-in-Q VLAN Setting	40
4.6 QUALITY OF SERVICE	41
4.7 OAM SETUP.....	44
4.7.1 Local TS-1000 OAM Setup	44
4.7.2 Remote TS-1000 OAM Setup	45
4.7.3 TS-1000 Loop Back Test	47
4.7.4 802.3ah Setup.....	49
4.7.5 802.3ah Loop Back Test	50
4.8 SECURITY	52
4.9 LOGOUT	53
5. TROUBLESHOOTING	54
APPENDIX A NETWORKING CONNECTION	55
A.1 DEVICE'S RJ-45 PIN ASSIGNMENTS	55
A.2 RJ-45 CABLE PIN ASSIGNMENT	55
A.3 FIBER OPTICAL CABLE CONNECTION PARAMETER.....	56
A.4 POWER INFORMATION.....	57
A.5 AVAILABLE MODULES.....	57

1. INTRODUCTION

1.1 Package Contents

Check the contents of your package for following parts:

- Managed Gigabit Ethernet Media Converter x1
- CD-ROM user's manual x1
- Quick installation guide x1
- External DC 5V / 2A power adapter x 1

If any of these are missing or damaged, please contact your dealer immediately, if possible, retain the carton including the original packing material, and use them against to repack the product in case there is a need to return it to us for repair.

 **Notice:** GT-905A is with one vacant SFP module slot. The 1000Base-SX / LX SFP module is not bundled with in the package.

1.2 How to Use This Manual

The Managed Media Converter User's Manual is structured as followings:

Section 2, Hardware Installation

It explains the functions of Managed Media Converter and how to install the Managed Media Converter.

Section 3, Media Converter Management

It contains information about how to manage the Managed Media Converter.

Section 4, Web Management

It contains information about the management function from the Managed Media Converter.

Section 5, Troubleshooting

It contains troubleshooting guide of Managed Media Converter.

Appendix A

It contains cable information of Managed Media Converter.

The term of "**Managed Media Converter**" In the following section of this user's manual means the GT-90x.

1.3 About the Managed Media Converter

The Managed Media Converter **GT-90x** provide conversion between 10/100/1000Base-T and 1000Base-SX /LX network. There are SC / LC / WDM connectors and single-mode / multi-mode media for your needs. Ethernet signal that allows two type segments connect easily, efficiently and inexpensively. This Managed Media Converter can be used as a stand-alone unit or as a slide-in module to the PLANET Media Converter Chassis (**MC-700**, **MC-1000** and **MC-1500**).

The Managed Media Converter equipped with remote Web / SNMP interface. With its built-in Web-based management, the Managed Media Converter offers an easy-to-use, platform-independent management and configuration facility and can be programmed for advanced management functions. Such as IP address Configuration / DHCP Client function, password setting / firmware upgrade, system reboot / factory default, port configuration that include TP / Fiber port speed duplex mode setting, flow control setting and Ingress/Egress bandwidth control setting, converter configuration that include maximum packet length setting, Broadcast / Multicast / Unicast storm control setting, 16 IEEE 802.1Q VLAN groups support and powerful Q-in-Q VLAN function, Quality of Service (QoS), TS-1000 / IEEE 802.3ah OAM function and TCP & UDP filter function. It supports standard Simple Network Management Protocol (SNMP) and can be managed via any standard-based management software as well.

With Gigabit mini GBIC interface, the GT-905A is with high reliability and flexibility to extend the distance from 220m to 120Km. It depends on the Gigabit mini GBIC modules.

■ Application

Fiber-optic Networking for ISP, enterprise, and home

With high performance of data transmission and easy installation, the Managed Media Converter can build an ISP network solution of FTTH (Fiber to the Home) or FTTC (Fiber to the Curb) for ISPs and FTTB (Fiber to the Building) for small office network environment from enterprises. The Web Management helps network administrators to monitor and setup the converter, speed and duplex through web browsers.

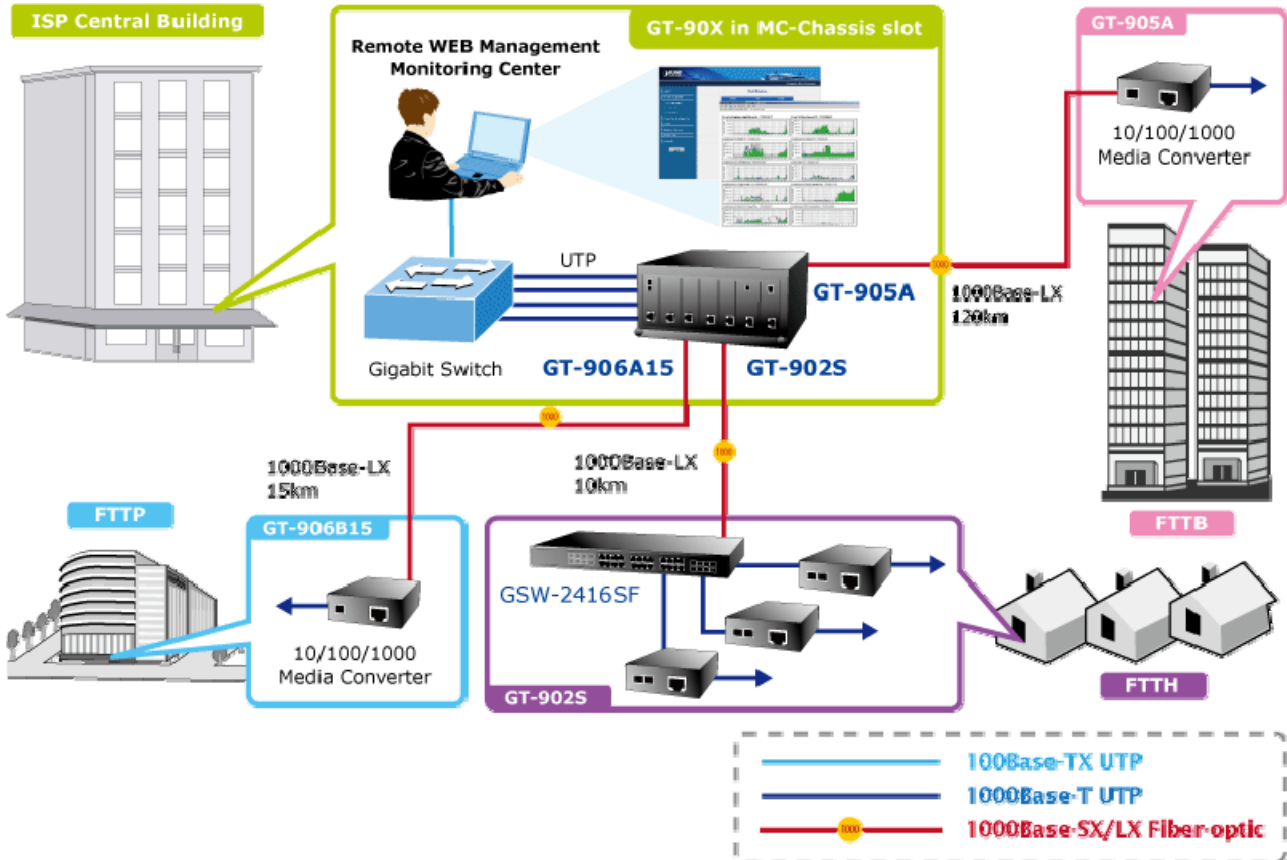

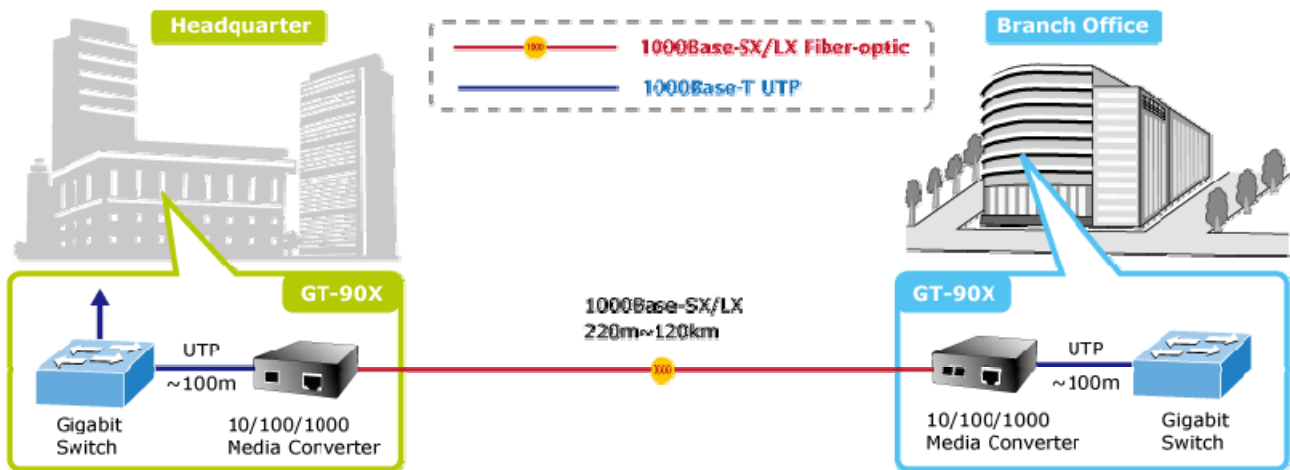

1.4 Product Features

- Complies with IEEE 802.3 10Base-T, IEEE 802.3u 100Base-TX, IEEE 802.3ab 1000Base-T, IEEE 802.3z 1000Base-SX/LX
- One-channel media conversion between 10/100/1000Base-T and 1000Base-SX / LX
- TP port supports 10/100/1000Base-T auto-negotiation and auto-MDI/MDI-X
- 1000Base-SX: 50/125 μ m or 62.5/125 μ m multi-mode fiber cable, up to 220/550m on **GT-902**
- 1000Base-LX: 9/125 μ m single-mode cable provides long distance for 10km on **GT-902S**
- 1000Base-LX WDM interface for up to 15km (single-mode fiber 9 μ m/125 μ m) on **GT-906A15/B15**
- 1000Base-LX WDM interface for up to 60km (single-mode fiber 9 μ m/125 μ m) on **GT-906A60/B60**
- 1000Base-T: 2-pair Cat. 5/5e/6 UTP cable, up to 100 meters
- Compact size for working with PLANET MC family Media Chassis (**MC-700/1000R/1500**)
- Wall-mountable hardware designed
- Built-in IP-Base **Web interface** for remote management
- Layer 2 Management Feature
 - Store-and-Forward mechanism
 - Built-in Web operation interface for remote management and setup
 - Manual IP address setting / DHCP client for IP address assignment
 - SNMP v1 / v2c monitor / private Enterprise MIB
 - Event trap and SNMP trap support
 - Speed duplex mode configuration / Flow Control setting / bandwidth Control on TP / Fiber port
 - Supports Port Status / Ethernet Statistics on both TP and Fiber interface
 - Supports Maximum frame size to 16K bytes
 - Loop detection / Broadcast / Multicast / Unicast storm control
 - Management VLAN / 16 IEEE 802.1Q VLAN groups / Q-in-Q VLAN
 - 802.1p Tag Priority / IP address priority / IP DSCP option in Quality of Service Mode and Strict Priority / Weighted Round Robin (WRR) QoS policies

- TS-1000 OAM / IEEE 802.3ah OAM / Loop Back Test
- 16 TCP / UDP Filter groups
- Password setting, IP setting and devices description setting through Planet Smart discovery utility
- Firmware upgrade via remote Web interface
- External DC5V 2A power supply
- Compact in size, easy installation
- LED indicators for easy network diagnosing
- Reset Button at the front panel for resetting the factory default
- Choice of fiber-connector from SC, LC, WDM, multi-mode / single-mode fiber /1000Base-SX / LX mini GBIC module

1.5 PRODUCT SPECIFICATION

Model	GT-902	GT-902S	GT-905A	GT-906A15	GT-906B15	GT-906A60	GT-906B60	
Hardware Specification								
Standards	IEEE 802.3, 10Base-T IEEE 802.3u, 100Base-TX IEEE 802.3ab, 1000Base-T IEEE 802.3z, 1000Base-SX/LX							
Ports	1 x 10/100/1000Base-T port, 1 x 1000Base-SX/LX port							
Copper Interface	RJ-45 port (Auto-MDI/MDI-X) Twisted Pair							
Optic Interface	SC		SFP	WDM				
Optic Wavelength	850nm	1310nm	-	TX:1310nm RX:1550nm	TX:1550nm RX:1310nm	TX:1310nm RX:1550nm	TX:1550nm RX:1310nm	
Launch Power(dBm)	Max.	-4 dBm	-3 dBm	-	-3 dBm	+5 dBm	-3 dBm	+4 dBm
	Min.	-9.5 dBm	-9.5dBm	-	-9 dBm	0 dBm	-9 dBm	-1 dBm
Receive Sensitivity	-13.5 dBm	-14.4 dBm	-	-21 dBm	-25 dBm	-21 dBm	-25 dBm	
Maximum Input power	-18 dBm	-20 dBm	-	-3 dBm	-3 dBm	-2 dBm	-2 dBm	
Speed	Twisted-pair	10/20Mbps for Half / Full-Duplex 100/200Mbps for Half / Full-Duplex 2000Mbps for Full-Duplex						
	Fiber-optic	2000Mbps for Full-Duplex						
Cable	Twisted-pair	10Base-T: 2-pair UTP Cat. 3,4,5, up to 100 m 100Base-TX: 2-pair UTP Cat. 5, up to 100 m 1000Base-T: 4-pair STP Cat 5 up to 100m						
	Fiber-optic Cable	<ul style="list-style-type: none"> ▪ 50/125µm or 62.5/125µm multi-mode fiber cable, up to 220/550m. ▪ 9/125µm single-mode cable, provides long distance for 10/15/20/30/40/50/60/70/120km (very on fiber transceiver or SFP module) 						
LED Indicator	<ul style="list-style-type: none"> • PWR, • TP LINK/ACT, 1000 • Fiber LINK/ACT 							

Power Consumption	3.8 Watts/ 13 BTU (maximum)
Power Input	DC 5V / 2A
Dimensions	94 x 70 x 26mm (W x D x H)
Operator Environment	Operating temperature: 0 to 50 Degree C; Humidity: 5~90% non-condensing
Storage Environment	storage temperature: -40 to 70 Degree C; Humidity: 5~90% non-condensing
Emissions	FCC Class A, CE Class A

2. HARDWARE DESCRIPTION

This product provides three different running speeds – 10Mbps, 100Mbps and 1000Mbps in the same Managed Media Converter and automatically distinguishes the speed of incoming connection.

This section describes the functionalities of GT-90X's components and guides how to install it on the desktop or shelf. Basic knowledge of networking is assumed. Please read this chapter completely before continuing.

2.1 GT-90X Front Panel

The Front Panel of the Managed Media Converter consists of one 1000Base-SX / 1000Base-LX / mini-GBIC SFP / 1000Base-LX WDM ports and one Auto-Sensing 10/100/1000Mbps Ethernet RJ-45 Port. Figure 2-1 & 2-2 & 2-3 shows a front panel of Managed Media Converter.

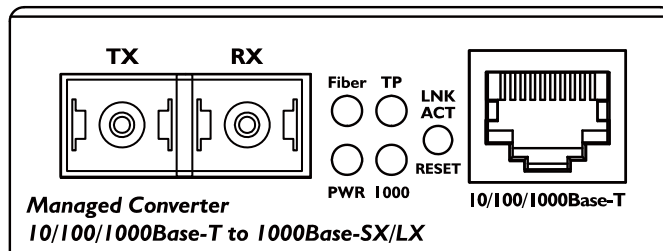

Figure 2-1 PLANET GT-902 / GT-902S Front Panel

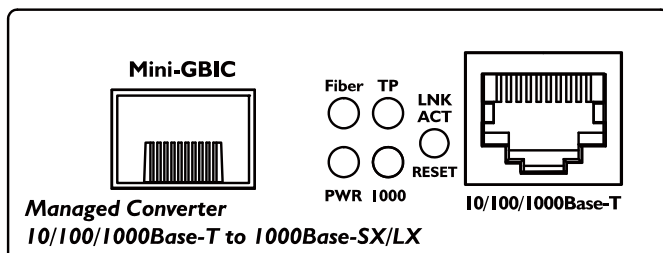

Figure 2-2 PLANET GT-905A Front Panel

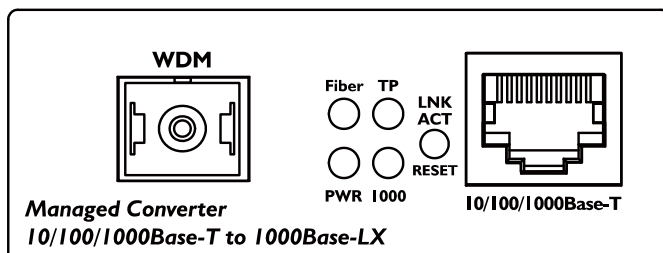

Figure 2-3 PLANET GT-906A/B Front Panel

2.1.1 LED Indicators

LED	Color	Description
PWR	Green	Lit: When +5VDC power detected.
Fiber LNK/ACT	Green	Lit: To indicate the link through that fiber port is successfully established. Blink: Indicate that the Fiber port is actively sending or receiving data over that port.
TP LNK/ACT	Green	Lit: To indicate the link through that port is successfully established. Blink: Indicate that the port is actively sending or receiving data over that port.
TP 1000	Green	Lit: When the port runs in 1000Mbps Full duplex mode Off: When the port runs in 10/100Mbps Half / Full duplex mode.



Notice:

To press and release the RESET button. The GX-90x will back to the factory default mode. Be sure that you backup the current configuration of GT-90X; else the entire configuration will be erased when pressing the **“RESET”** button.

- Press and release the RESET button shortly, the device will be rebooted.
- Press the RESET button more than 10 seconds, the device will back to the factory default mode; the entire configuration will be erased.

2.1.2 GT-90X Rear Panel

The rear panel of the Managed Media Converter indicates one DC jack, which accepts input power with 5V DC 2A.

■ **GT-90x series**

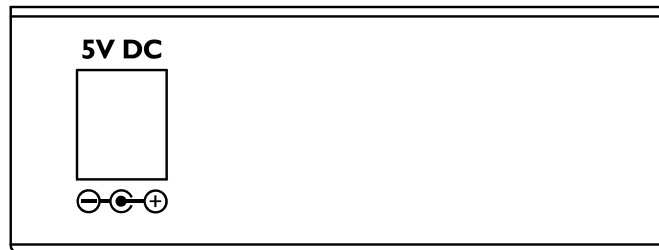

Figure 2-4 Rear Panel of GT-90x

Power Notice:

1. The device is a power-required device, it means, it will not work till it is powered. If your networks should active all the time, please consider using UPS (Uninterrupted Power Supply) for your device. It will prevent you from network data loss or network downtime.
2. In some area, installing a surge suppression device may also help to protect your Managed Media Converter from being damaged by unregulated surge or current to the converter or the power adapter.

2.2 Install the Converter

This section describes how to install your Managed Media Converter and make connections to the Managed Media Converter. Please read the following topics and perform the procedures in the order being presented. The hardware installation of Managed Media Converter do not need software configuration. To install your Managed Media Converter on a desktop or shelf, simply complete the following steps.

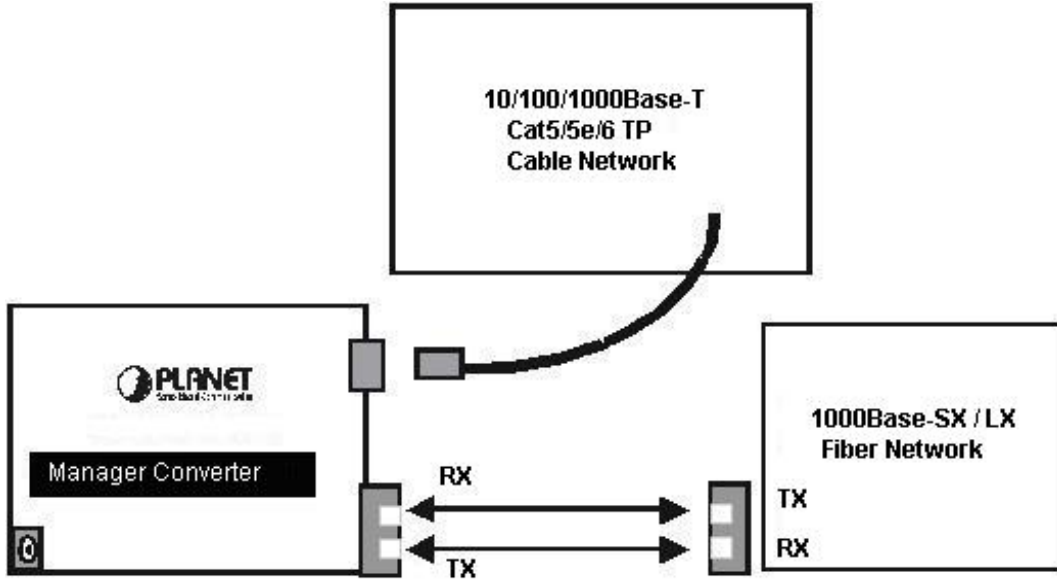

2.2.1 Stand-alone Installation

To install a Managed Media Converter stand-alone, on a desktop or shelf, simply complete the following steps:

- Step 1:** Turn off the power of the device/station in a network to which the Managed Media Converter will be attached.
- Step 2:** Ensure that there is no activity in the network.
- Step 3:** Attach fiber cable from the Managed Media Converter to the fiber network. TX, RX must be paired at both ends.
- Step 4:** Connect the 5VDC power adapter to the Managed Media Converter and verify that the Power LED lights up.
- Step 5:** Turn on the power of the device/station; the PWR LEDs should light when all cables are attached.

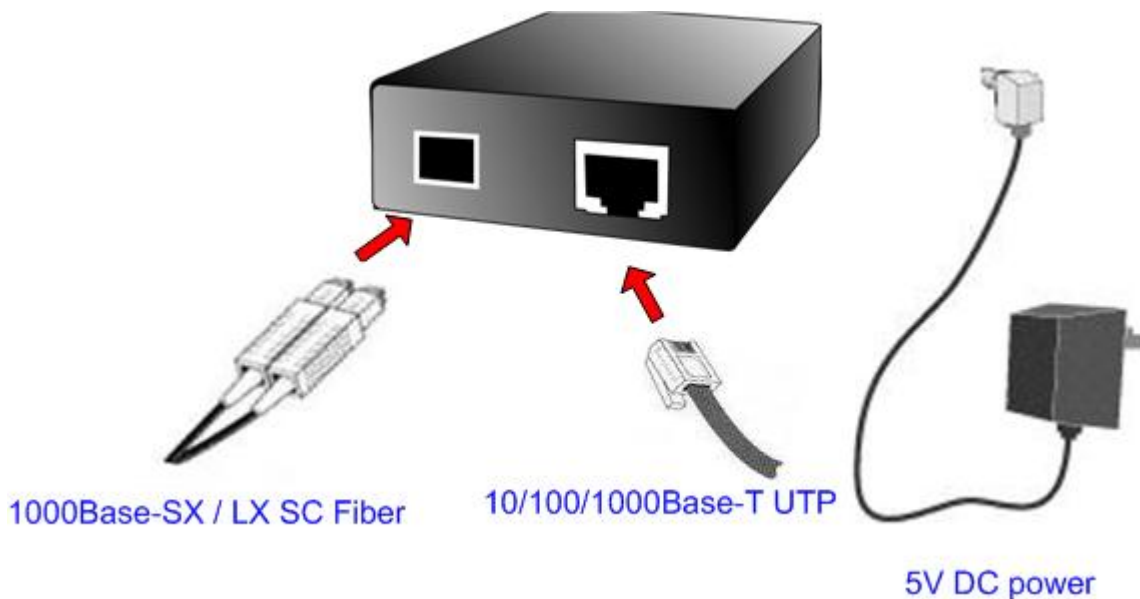



Notice: Please refer to APPENDIX-A for detailed wiring information of the Managed Media Converter. To prevent from optic acceptor malfunction, check the both wires / transmitter before power on the converter.

■ GT-905A Installation

GT-905A is with high reliability and flexibility to extend the distance from 220m to 120Km. It depends on the Gigabit mini GBIC modules. The SFP transceivers are hot-plug and hot-swappable. You can plug-in and out the transceiver to/from any SFP port without having to power down the converter.

To install GT-905A with 1000Base-SX / LX SFP, simply complete the following steps:

Step 1: Proceed with the steps 4 and steps 5 of session 2.2.1 **Stand-alone Installation** to connect the network cabling and supply power to your converter.

Step 2: Slot in the 1000Base-SX / LX SFP. Make sure both side of the SFP transceiver are with the same media type, for example: 1000Base-SX / 220m & 550m to 1000Base-SX / 220m & 550m, 1000Base-LX / 10km to 1000Base-LX / 10km

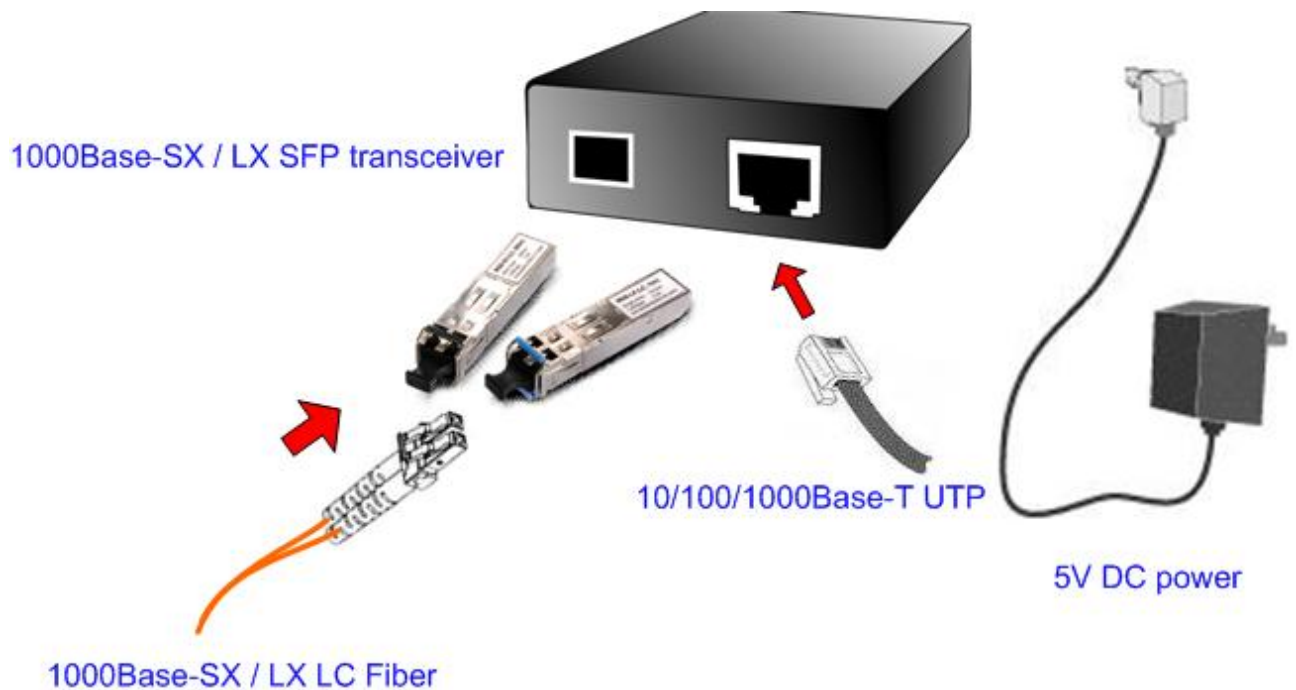

Step 3: Connect the fiber cable. Attach the duplex LC connector on the network cable into the SFP transceiver.



Notice: It recommends using PLANET MGB series 1000Base-SX / LX / LX WDM SFP on the GT-905A. If you insert a SFP transceiver that is not supported, the GT-905A will not recognize it.

2.2.2 Chassis Installation and Rack Mounting

To install the Managed Media Converter in a **10-inch** or **19-inch** with standard rack, follow the instructions described below.

Step 1: Place your Managed Media Converter on a hard flat surface, with the front panel positioned towards your front side.

Step 2: Carefully slide in the module until it is fully and firmly fitted into the slot of the chassis.



Figure 2-5: Insert a Managed Media Converter into an available slot

Step 3: Attach a rack-mount bracket to each side of the Chassis with supplied screws attached to the package.

Step 4: After the brackets are attached to the chassis, use suitable screws to securely attach the brackets to the rack, as shown in [Figure 2-6](#).

Step 5: Precede with the steps 4 and steps 5 of session **2.2.1 Stand-alone Installation** to connect the network cabling and supply power to your Chassis.

Caution: You must use the screws supplied with the mounting brackets. Damage caused to the parts by using incorrect screws would invalidate your warranty.

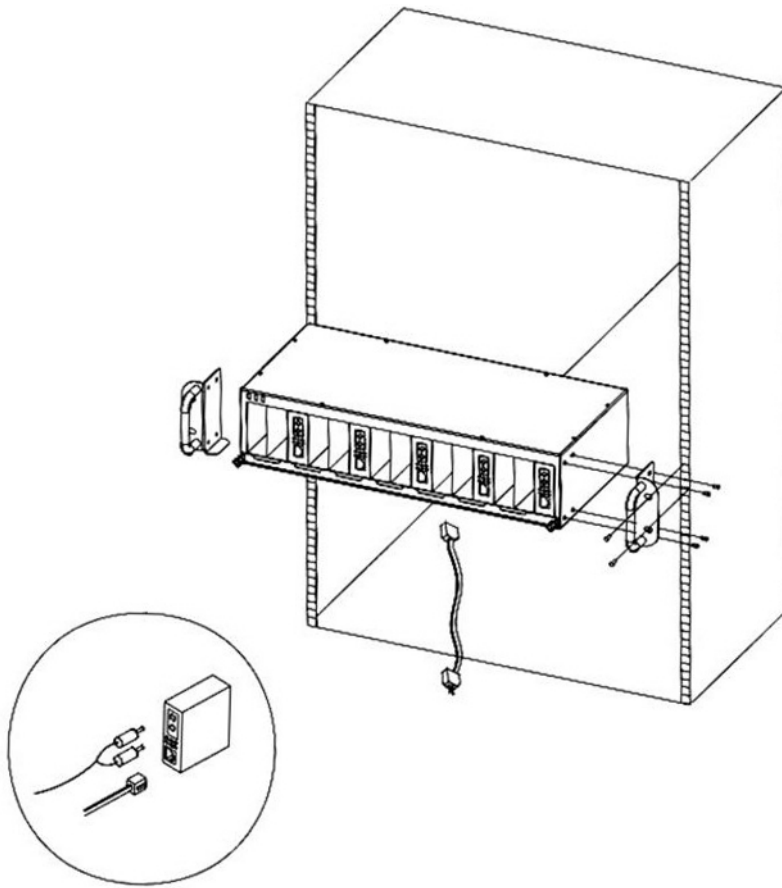

Figure 2-6 Mounting the Chassis in a Rack

3. MEDIA CONVERTER MANAGEMENT

This chapter describes how to manage the Managed Media Converter. Topics include:

- Overview
- Management methods
- Assigning an IP address to the Managed Media Converter
- Logging on to the Managed Media Converter

3.1 Overview

This chapter gives an overview of Managed Media Converter management. The GT-90X provides a simply WEB **browser interface**. Using this interface, you can perform various Managed Media Converter configuration and management activities, including:

- **System**
- **Port Management**
- **Converter Configuration**
- **VLAN**
- **Quality of Service**
- **OAM Setup**
- **Security**
- **Logout**

Please refer to the following Chapter 4 for more details.

3.2 Management Methods

The way to manage the GT-90X:

- Web Management via a network or dial-up connection.
- Using SNMP Network Management Station.

3.2.1 Web Management

The PLANET Managed Media Converter provides a built-in browser interface. You can manage the Managed Media Converter remotely by having a remote host with Web browser, such as Microsoft Internet Explorer, Netscape Navigator or Mozilla Firefox.

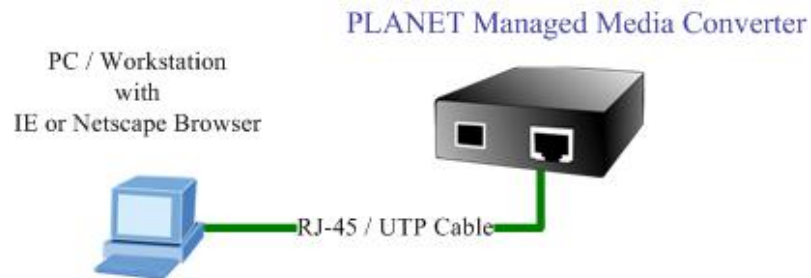

The following shows how to startup the Web Management of the Managed Media Converter, please note the Managed Media Converter is configured through an Ethernet connection, make sure the manager PC must be set on the same **IP subnet address**, for example, the default IP address of the Managed Media Converter is **192.168.0.100** (the factory-default IP address), then the manager PC should be set at 192.168.0.x (where x is a number between 1 and 254, except 100), and the default subnet mask is 255.255.255.0.

Use Internet Explorer 5.0 or above Web browser, enter default IP address <http://192.168.0.100>

After entering the username and password (default user name and password is “**admin**”) in login screen then the Web main screen appears.

3.2.2 SNMP Management

You can manage the Managed Media Converter across a LAN using an SNMP Network Management Station with a graphical user interface.

This management method lets you monitor statistical counters and set Managed Media Converter parameters from the remote Network Management Station.

Using this management method:

- The network must run the IP protocol.
- The Managed Media Converter must have an IP address.

3.2.3 PLANET Smart Discovery Utility

For easily list the Managed Media Converter in your Ethernet environment, the Planet Smart Discovery Utility from user's manual CD-ROM is an ideal solution.

The following install instructions guiding you for run the Planet Smart Discovery Utility.

1. Deposit the Planet Smart Discovery Utility in administrator PC.
2. Run this utility and the following screen appears.

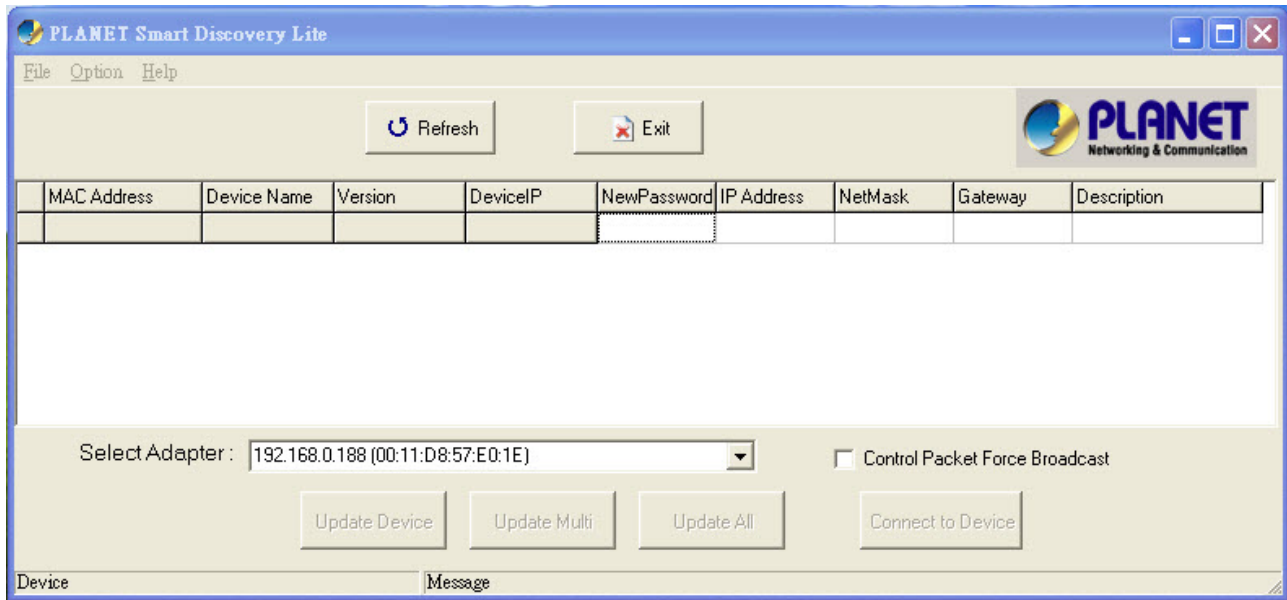

Figure 3-1 Planet Smart Discovery Utility Screen

Notice: If there are two LAN cards or above in the same administrator PC, choose different LAN card by use the “**Select Adapter**” tool.

3. Press “**Refresh**” button for list current connected devices in the discovery list, the screen is shown as follow.

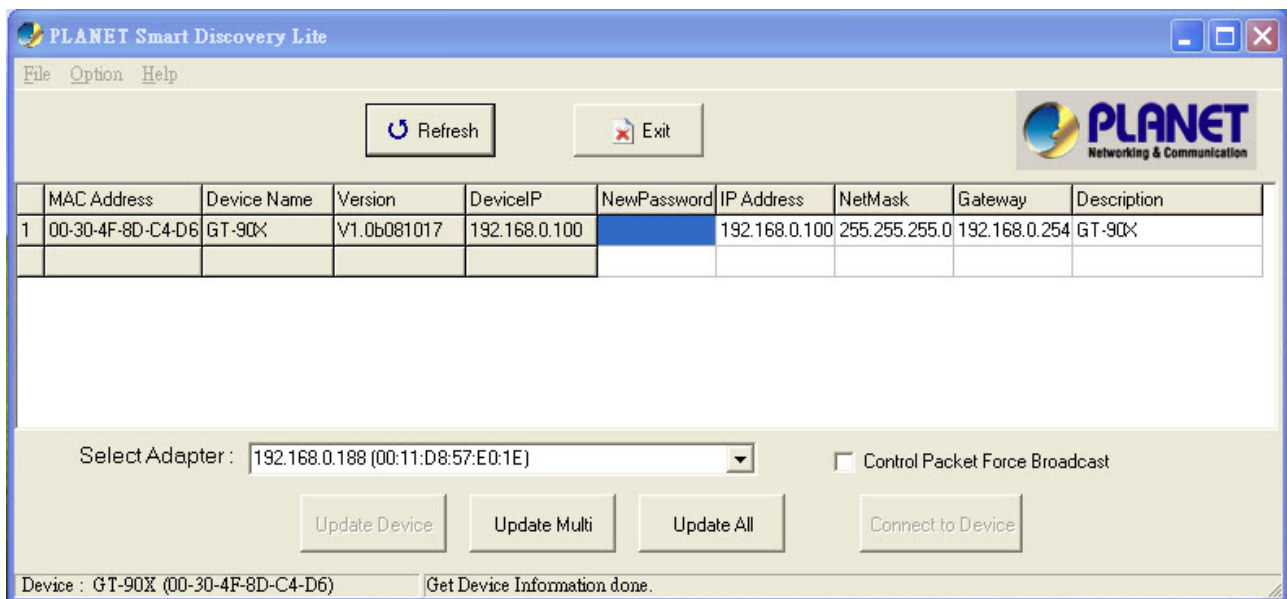

Figure 3-2 Planet Smart Discovery Utility Screen

3. This utility show all necessary information from the devices, such as MAC Address, Device Name, firmware version, Device IP Subnet address, also can assign new password, IP Subnet address and description for the devices.
4. After setup completed, press “**Update Device**”, “**Update Multi**” or “**Update All**” button to take affect. The meaning of the 3 buttons above are shown as below:
 - Update Device:** use current setting on one single device.
 - Update Multi:** use current setting on choose multi-devices.
 - Update All:** use current setting on whole devices in the list.
 The same functions mentioned above also can be finding in “**Option**” tools bar.
5. To click the “**Control Packet Force Broadcast**” function, it can allow assign new setting value to the Managed Media Converter under different IP subnet address.
6. Press “**Connect to Device**” button then the Web login screen appears in [Figure 3-3](#).
7. Press “**Exit**” button to shutdown the planet Smart Discovery Utility.

3.2.4 Login the Managed Media Converter

Before you start configure the Managed Media Converter, please note the Managed Media Converter is configured through an Ethernet connection, make sure the manager PC must be set on same the **IP subnet address**. For example, the default IP address of the Managed Media Converter is **192.168.0.100**, then the manager PC should be set at 192.168.0.x (where x is a number between 2 and 254), and the default subnet mask is 255.255.255.0. Use Internet Explorer 6.0 or above Web browser. Enter IP address **http://192.168.0.100** (the factory-default IP address) to access the Web interface.

When the following login screen appears, please enter the default username and password (default user name and password is “**admin**”). Press Login to enter the main screen of Managed Media Converter. The login screen in [Figure 3-3](#) appears.

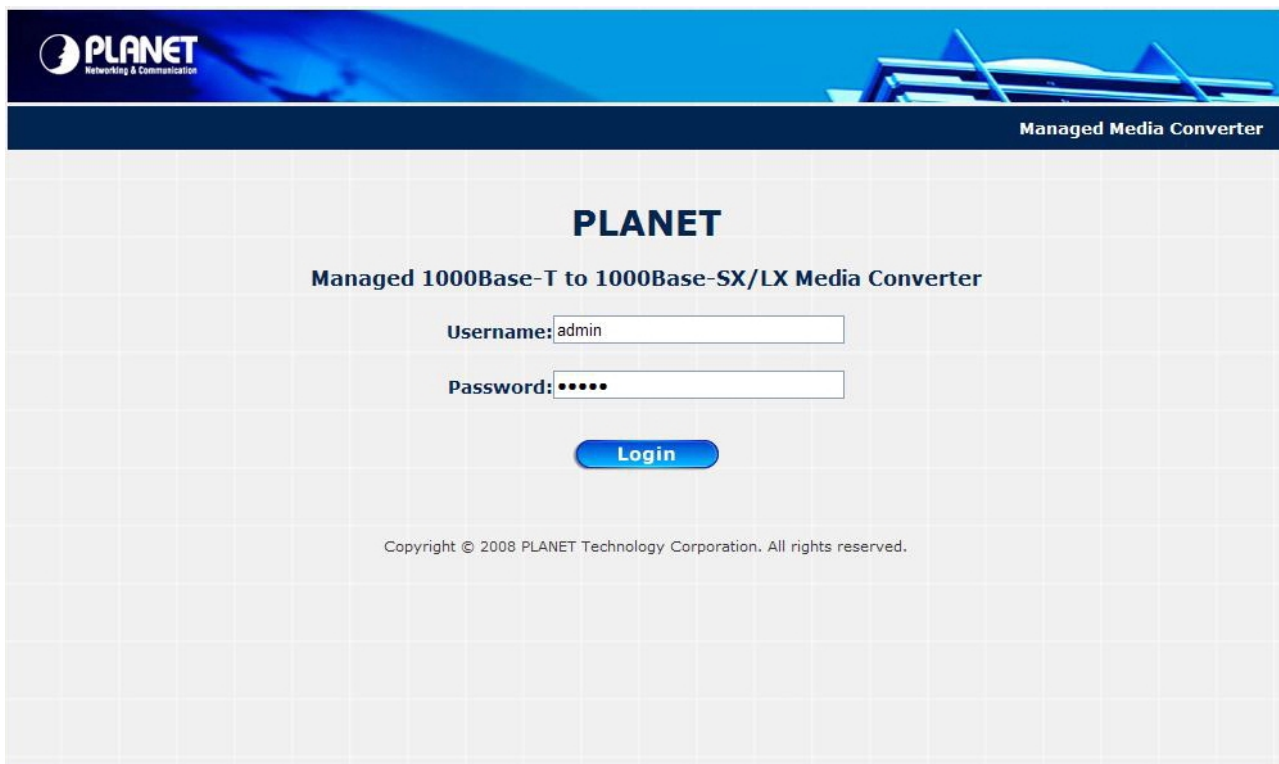

Figure 3-3 Login Web Page screen



Notice:

1. For security reason, please change and memorize the new password after this first setup.
2. Only accept command in lowercase letter under web interface.

4. WEB MANAGEMENT

The GT-90X Managed Media Converter provide Web interface for management function configuration and make the Managed Media Converter operate more effectively - They can be configured through the Web Browser. A network administrator can manage and monitor the Managed Media Converter from the local LAN. This section indicates how to configure the Managed Media Converter to enable its management function.

4.1 Main Menu

After a successful login, the main screen appears, the main screen displays the Managed Media Converter Welcome page. The screen in [Figure 4-1](#) appears.

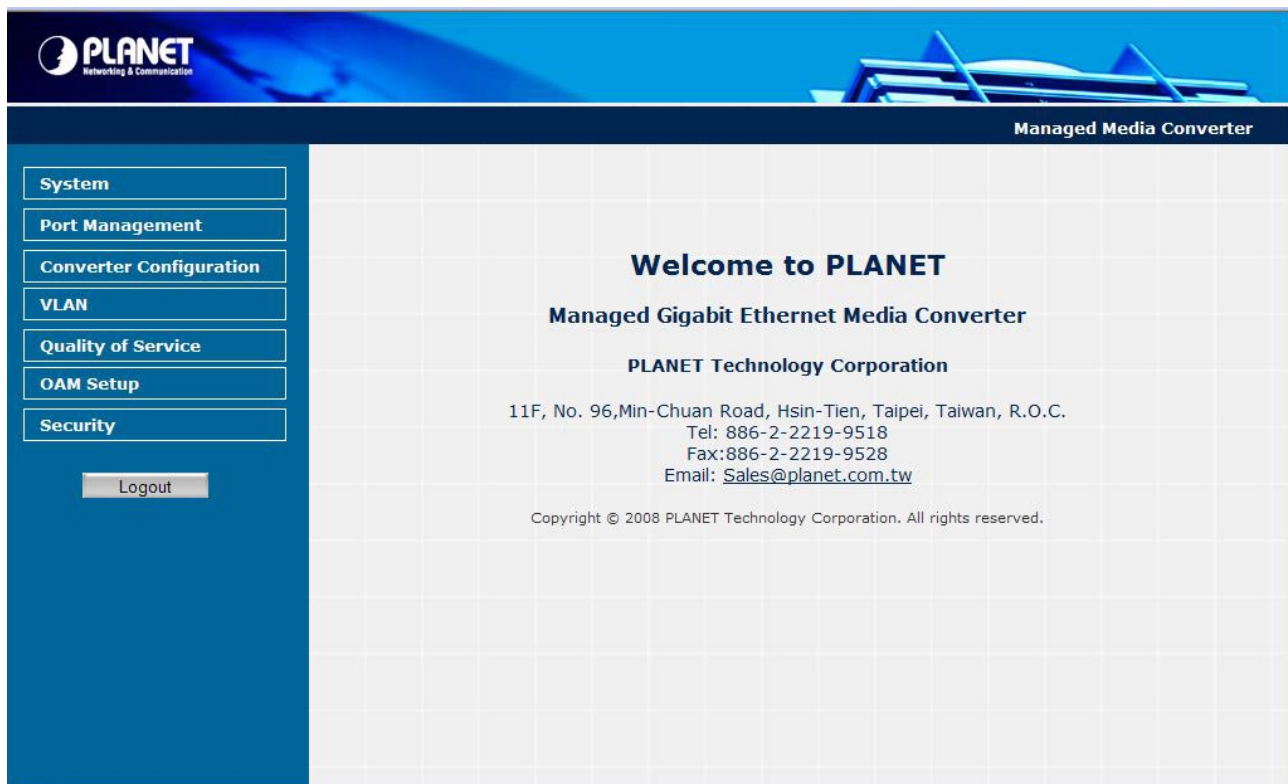

Figure 4-1 Web Main screen

As listed at the left of the main screen, the configurable management functions are shown as below:

- ◆ **System** – Provide System configuration of Managed Media Converter. [Explained in section 4.2.](#)
- ◆ **Port Management** – Provide Port Management configuration of Managed Media Converter. [Explained in section 4.3.](#)
- ◆ **Converter Configuration** – Provide Converter configuration of Managed Media Converter. [Explained in section 4.4.](#)
- ◆ **VLAN** – Provide VLAN configuration of Managed Media Converter. [Explained in section 4.5.](#)
- ◆ **Quality of Service** – Provide Quality of Service (QoS) function of the Managed Media Converter. [Explained in section 4.6.](#)
- ◆ **OAM Setup** – Provide OAM Setup function of the Managed Media Converter. [Explained in section 4.7.](#)
- ◆ **Security** – Provide Security function of the Managed Media Converter. [Explained in section 4.8.](#)
- ◆ **Logout**– Provide Logout function of the Managed Media Converter. [Explained in section 4.9.](#)

4.2 System

4.2.1 System Information

The System Information Web page provides information for the current device. System Information Web page helps network administrator to identify the firmware versions, IP Subnet Address and etc. The screen in [Figure 4-2](#) appears and [Table 4-1](#) describes the System Information object of Managed Media Converter.

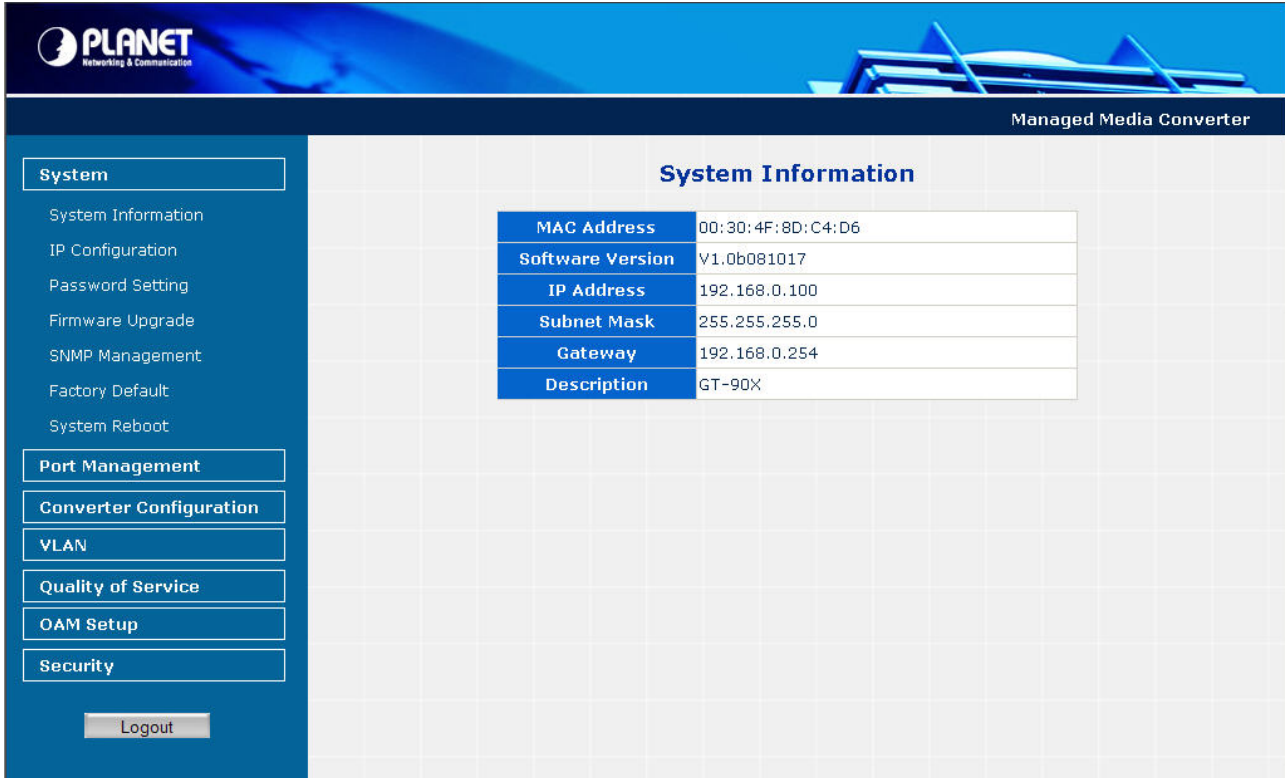

Figure 4-2 System Information Web page screen

The System Information Web page screen includes the following fields:

MAC Address	Specifies the MAC address of Managed Media Converter.
Software Version	The current software version running on the Managed Media Converter.
IP Address	The current IP Address of Managed Media Converter, the default IP Address is 192.168.0.100.
Subnet Mask	The current Subnet Mask of Managed Media Converter, the default Subnet Mask is 255.255.255.0.
Gateway	The current gateway of Managed Media Converter, the factory default gateway is 192.168.0.254.
Description	The current description of Managed Media Converter, the factory default description is GT-90X.

Table 4-1 Descriptions of the System Information Web Page Screen Objects

4.2.2 IP Configuration

The IP Configuration includes the DHCP Client, IP Address, Subnet Mask, Gateway and Description. The screen in [Figure 4-3](#) appears and [Table 4-2](#) describes the IP Configuration object of Managed Media Converter.

The screenshot shows the 'IP Configuration' web page. On the left is a navigation menu with categories: System, Port Management, Converter Configuration, VLAN, Quality of Service, OAM Setup, and Security. The 'System' category is selected, showing options like System Information, IP Configuration, Password Setting, Firmware Upgrade, SNMP Management, Factory Default, and System Reboot. The main area displays the 'IP Configuration' settings in a table format with an 'Apply' button below it.

IP Configuration	
DHCP Client	Disable
IP Address	192.168.0.100
Subnet Mask	255.255.255.0
Gateway	192.168.0.254
Description	GT-90X

Figure 4-3 IP Configuration Web page screen

The IP Configuration Web page screen includes the following configurable data:

DHCP Client	Allow disable or enable the DHCP Client function of the Managed Media Converter, the factory default mode is Disable .
IP Address	Allow assigning a new IP address for the Managed Media Converter, the factory default IP address is 192.168.0.100 .
Subnet Mask	Allow assigning a new subnet mask for the Managed Media Converter, the factory default subnet mask is 255.255.255.0 .
Gateway	Allow assigning a new gateway for the Managed Media Converter, the factory default gateway is 192.168.0.254 .
Description	Allow to input a new description for the Managed Media Converter, up to maximum 32 characters allow.
Apply button	Press " Apply " button for save current configuration of Managed Media Converter.

Table 4-2 Descriptions of the IP Configuration Web Page Screen Objects

Notice: After change the default IP subnet address, if you forget the IP subnet address. Please press the "**Reset**" button in the front panel of Managed Media Converter for 10 seconds, the current setting will be lost and the Managed Media Converter will restore to factory default mode.

4.2.3 Password Setting

This function provides administrator to secure Web login. The screen in Figure 4-4 & 4-5 appears and Table 4-3 describes the Password Setting object of Managed Media Converter.

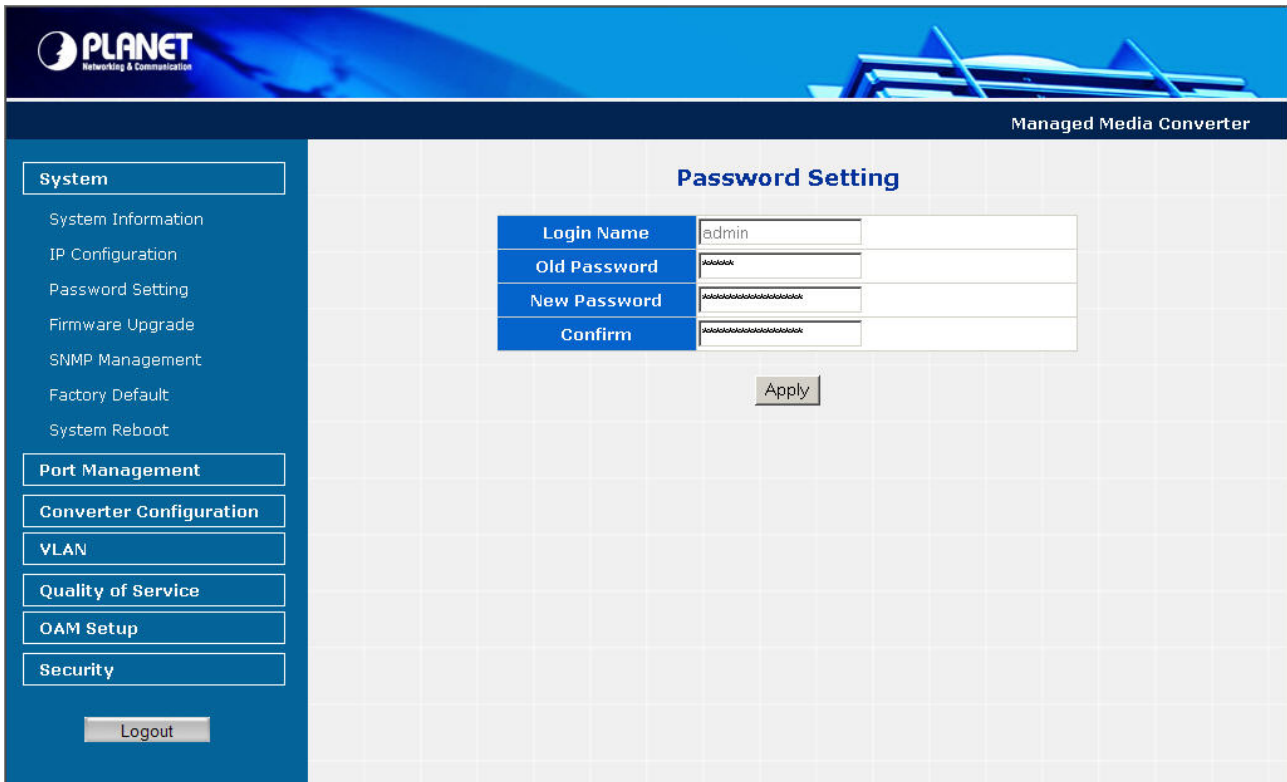

The screenshot shows the 'Password Setting' web page. The top header features the PLANET logo and the text 'Managed Media Converter'. A left sidebar contains a menu with categories: System, Port Management, Converter Configuration, VLAN, Quality of Service, OAM Setup, and Security. The 'System' category is expanded, showing options like System Information, IP Configuration, Password Setting, Firmware Upgrade, SNMP Management, Factory Default, and System Reboot. The main content area is titled 'Password Setting' and contains a form with four fields: 'Login Name' (containing 'admin'), 'Old Password', 'New Password', and 'Confirm'. An 'Apply' button is located below the form.

Figure 4-4 Password Setting Web page screen

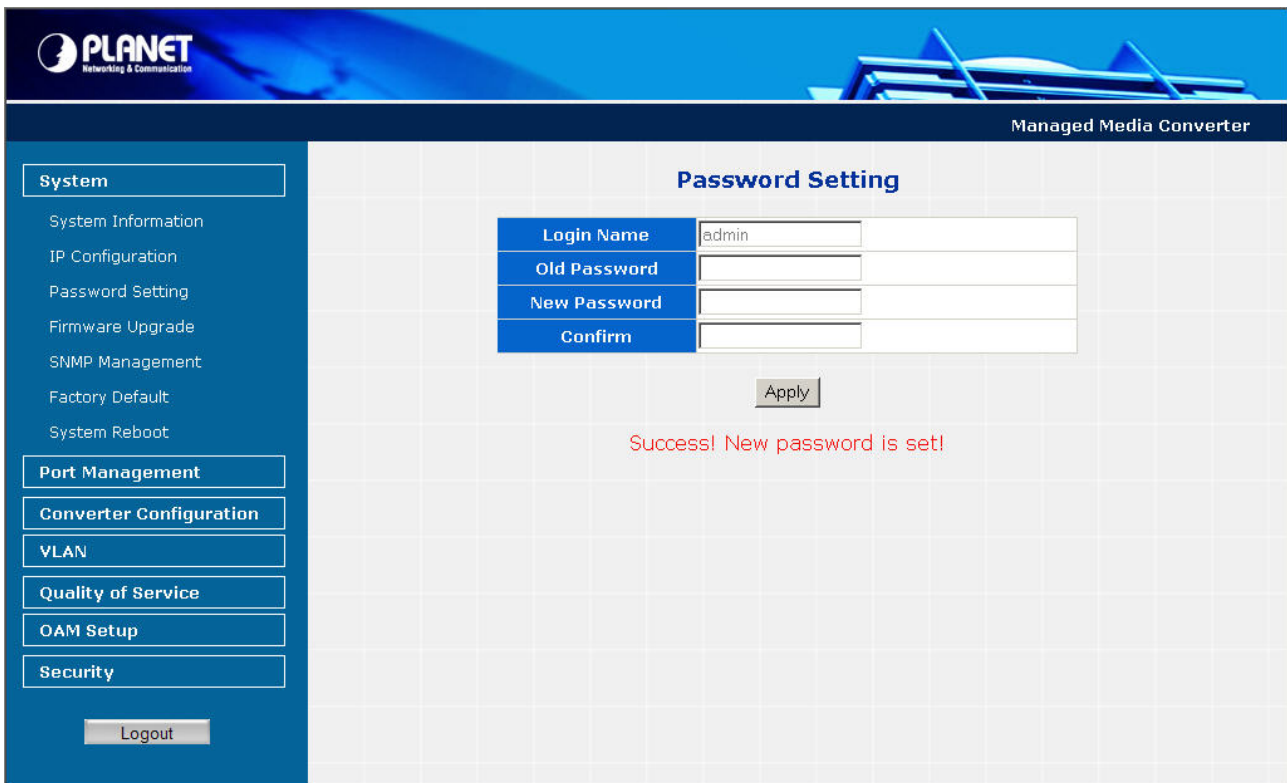

The screenshot shows the 'Password Setting Successful' web page. The layout is identical to Figure 4-4, but the 'Old Password', 'New Password', and 'Confirm' fields are now empty. Below the 'Apply' button, a red message reads 'Success! New password is set!'.

Figure 4-5 Password Setting Successful Web page screen

The Password Setting Web page includes the following configurable data:

Login Name	Displays the user name (admin).
Old Password	Enter the old password is required before entering the new password.
New Password	Specifies the new password. The password is not displayed. As it entered an “•” corresponding to each character is displayed in the field. (The maximum length is 16 characters)
Confirm	This confirms the new password. The password entered into this field must be exactly the same as the password entered in the Password field.
Apply button	Press “ Apply ” button for save current configuration of Managed Media Converter.

Table 4-3 Descriptions of the Password Setting Web Page Screen Objects

4.2.4 Firmware Upgrade

This function provides Firmware Upgrade of the Managed Media Converter and the screen in [Figure 4-6](#) appears.

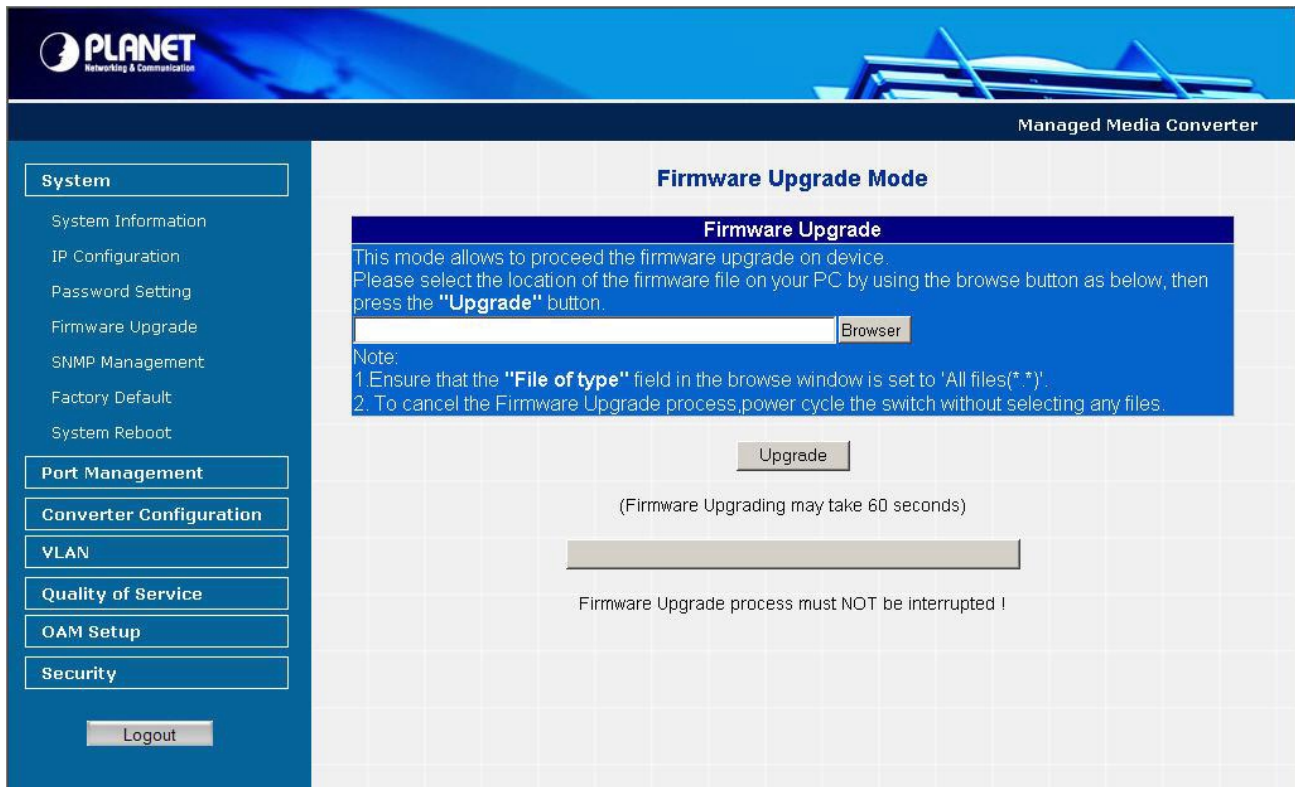

Figure 4-6 Firmware Upgrade Web page screen

Press **"Browser"** button to find the firmware location administrator PC, The screen in Figure 4-7 appears

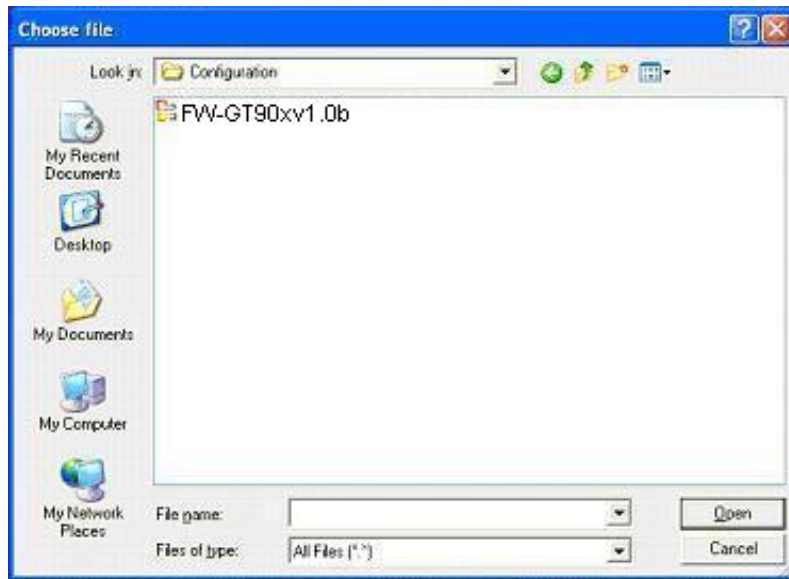

Figure 4-7 Firmware Upgrade Web page screen

After find the firmware location from administrator PC, press **"Upgrade"** button to start the firmware upgrade process. The screen in Figure 4-8 & 4-9 appears.

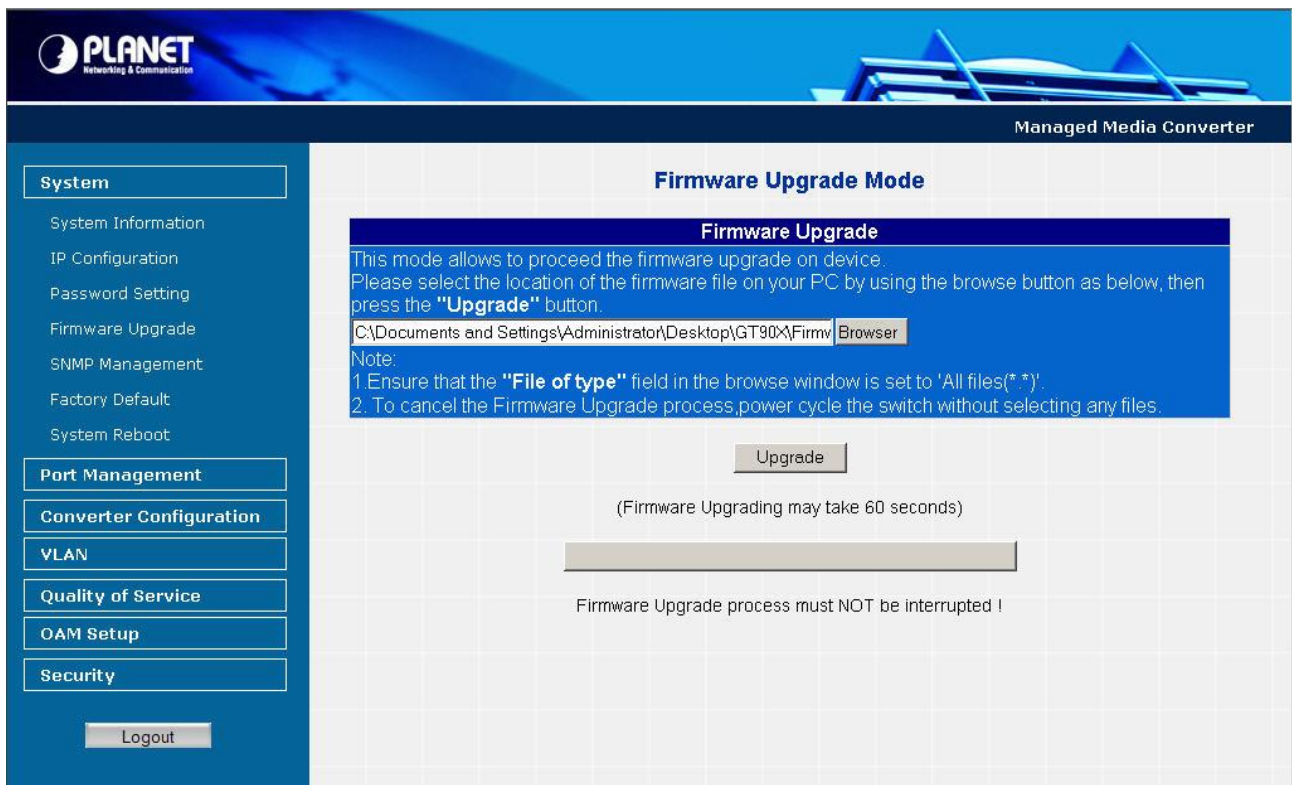

Figure 4-8 Firmware Upgrade Web page screen

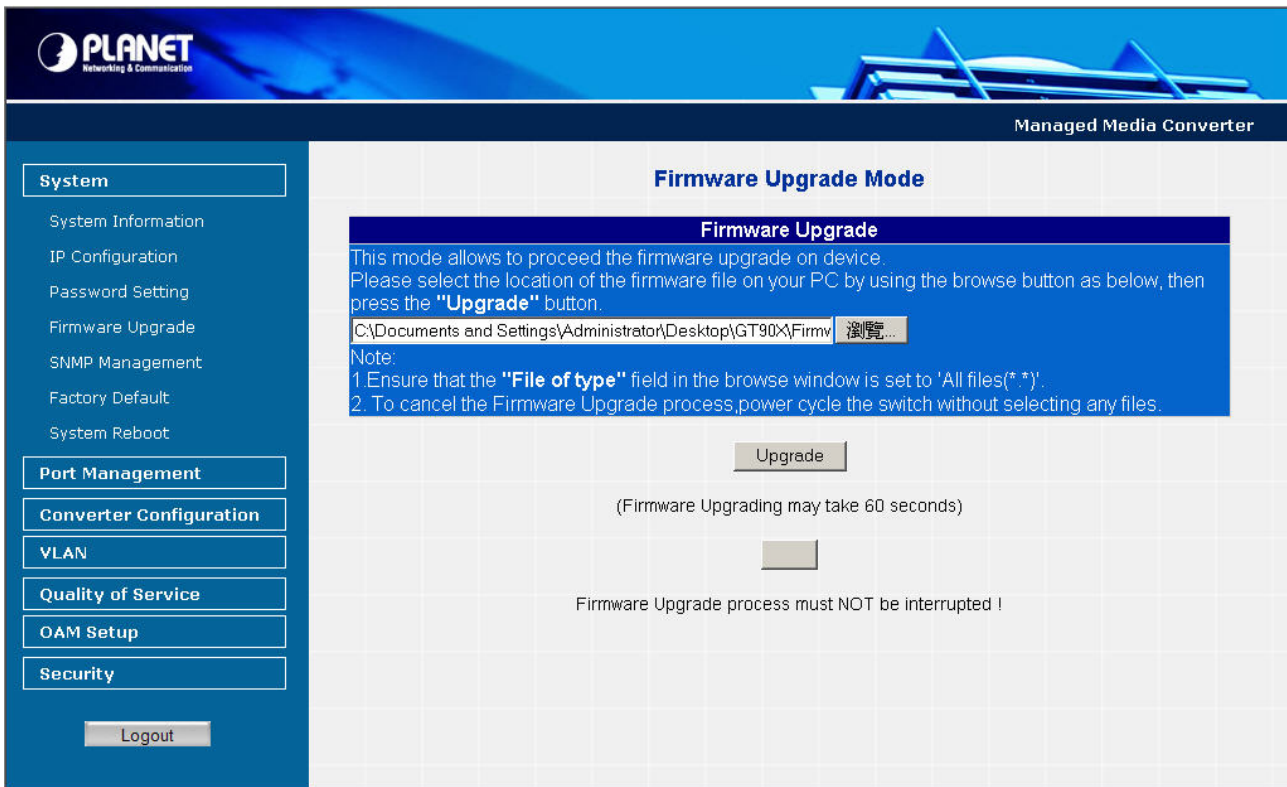

Figure 4-9 Firmware Upgrade Web page screen

When firmware upgrade process is completed then the following screen appears, please click **“here”** to re-login the Managed Media Converter with latest firmware and the screen in [Figure 4-10 & 4-11](#) appears.

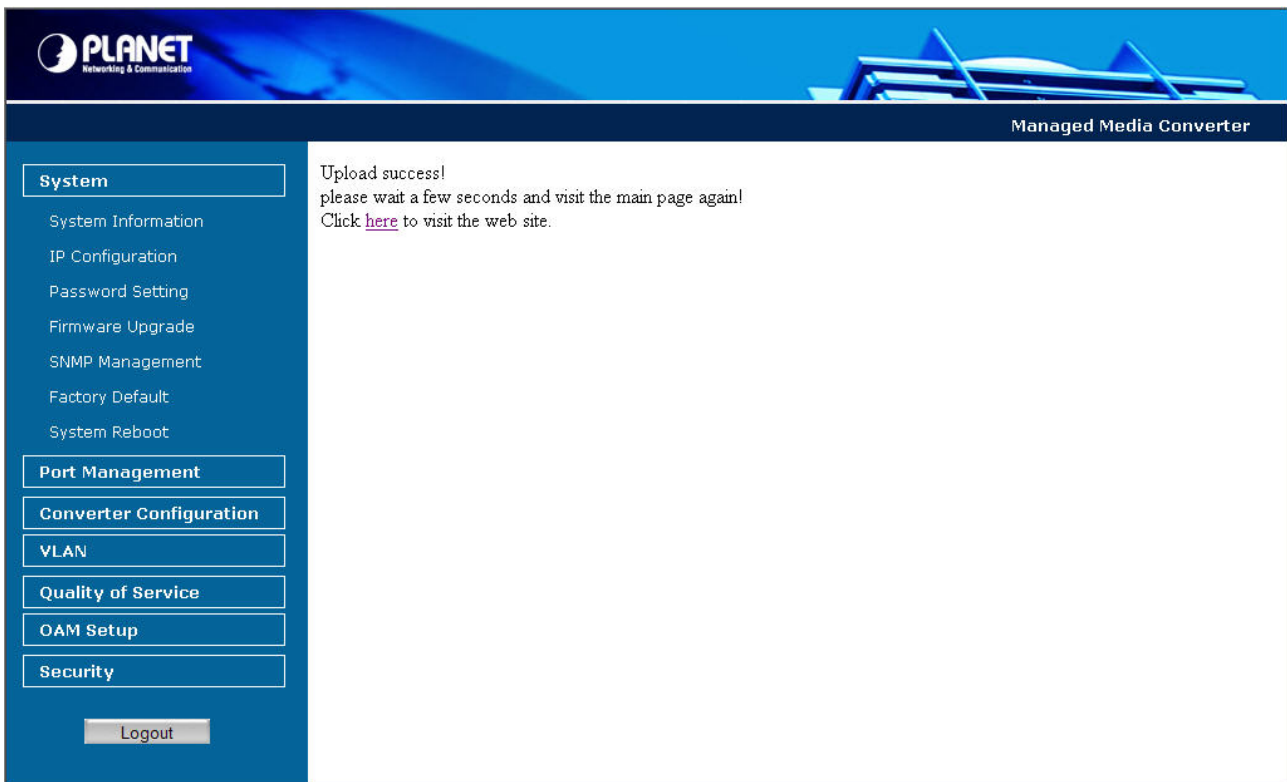

Figure 4-10 Firmware Upgrade Web page screen

PLANET

Managed 1000Base-T to 1000Base-SX/LX Media Converter

Username:

Password:

Login

Copyright © 2008 PLANET Technology Corporation. All rights reserved.

Figure 4-11 Login Web page screen

4.2.5 SNMP Management

This function provides SNMP Management and SNMP Trap Receiver Configuration function of the Managed Media Converter and the screen in Figure 4-12 & 4-13 appears and Table 4-4 & 4-5 describes the SNMP Management and SNMP Trap Receiver object of Managed Media Converter.

The image shows a web interface titled "SNMP Management". It contains a table of configuration fields:

Field Name	Value
SNMP Agent	Disable
SNMP Read Community	public
SNMP Write Community	private
System Name	GT-90X
System Location	
Contact	

Below the table is an "Apply" button.

Figure 4-12 SNMP Management Web page screen

The SNMP Management Web page includes the following configurable data:

SNMP Agent	Allow disable or enable the SNMP Agent function, the default mode is “Disable”.
SNMP Read Community	Allow input the characters for SNMP Read Community, up to maximum 16 characters allow.
SNMP Write Community	Allow input the characters for SNMP Write Community, up to maximum 16 characters allow.
System Name	Allow input the characters for System Name, up to maximum 16 characters allow.
System Location	Allow input the characters for System Location, up to maximum 16 characters allow.
Contact	Allow input the characters for Contact person, up to maximum 16 characters allow.
Apply button	Press “Apply” button for save current configuration of Managed Media Converter.

Table 4-4 Descriptions of the SNMP Management Web Page Screen Objects

Notice: The GT-90x supports SNMP v1 / v2c.

SNMP Trap Receiver Configuration

SNMP Trap	Disable ▾
SNMP Trap Destination	192.168.0.99
Trap Event	<input checked="" type="checkbox"/> Cold Start
	<input checked="" type="checkbox"/> Warm Start
	<input checked="" type="checkbox"/> Login Fail
	<input checked="" type="checkbox"/> Link Up
	<input checked="" type="checkbox"/> Link Down
<input type="button" value="Apply"/>	

Figure 4-13 SNMP Trap Receiver Configuration Web page screen

The SNMP Trap Receiver Configuration Web page includes the following configurable data:

SNMP Trap		Allow disable or enable the SNMP Trap function, the default mode is “Disable” .
SNMP Trap Destination		Allow input the IP address of SNMP Trap Destination.
Trap Event	Cold Start	When Managed Media Converter executes Cold Start operation, the administrator PC (SNMP Trap Destination) will receive a Cold Start Trap.
	Warm Start	When Managed Media Converter executes Warm Start operation, the administrator PC (SNMP Trap Destination) will receive a Warm Start Trap.
	Login Fail	When Web login fail situation appears on Managed Media Converter, the administrator PC (SNMP Trap Destination) will receive a Login Fail Trap.
	Link Up	When TP or Fiber port connection is build up, the administrator PC (SNMP Trap Destination) will receive a Link Up Trap.
	Link Down	When TP or Fiber port connection is Disconnect, the administrator PC (SNMP Trap Destination) will receive a Link Down Trap.
Apply button		Press “Apply” button for save current configuration of Managed Media Converter.

Table 4-5 Descriptions of the SNMP Trap Receiver Configuration Web Page Screen Objects

4.2.6 Factory Default

This function provides Factory Default function of the Managed Media Converter and the screen in [Figure 4-14 & 4-15 & 4-16](#) appears.

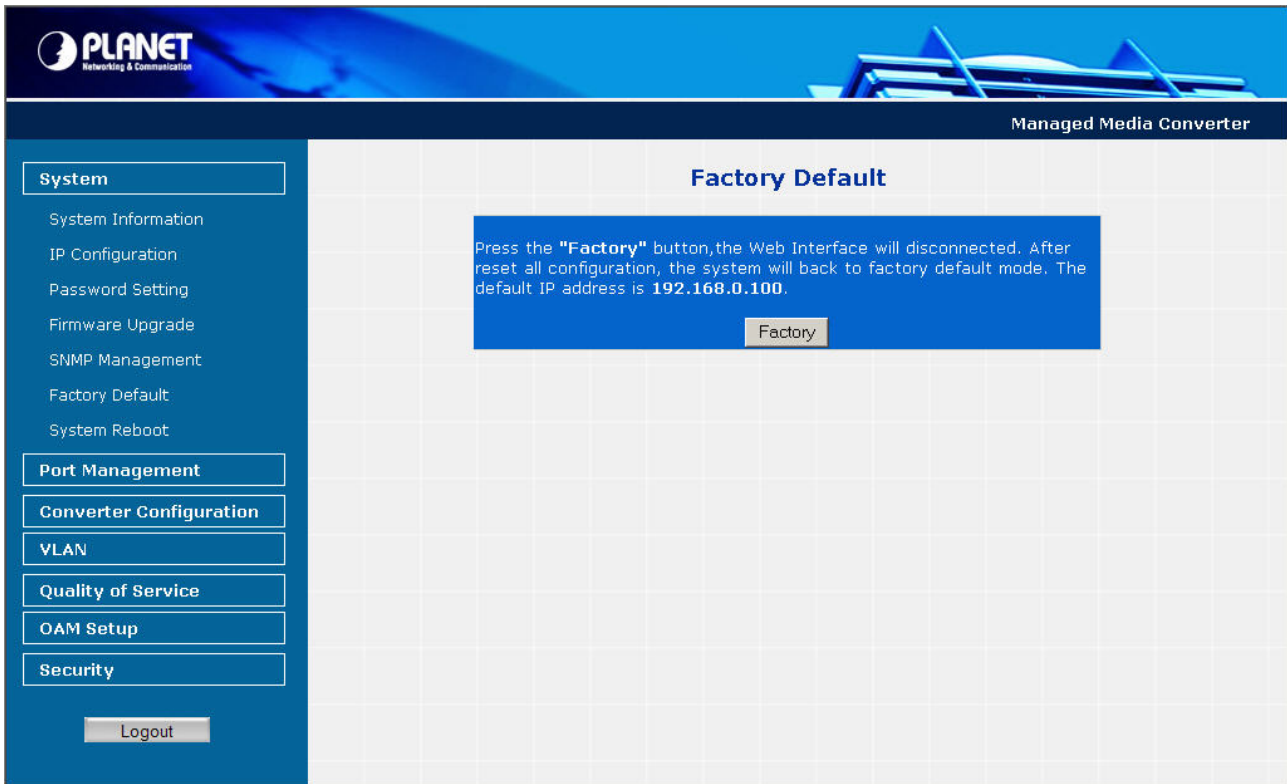

Figure 4-14 Factory Default Web page screen

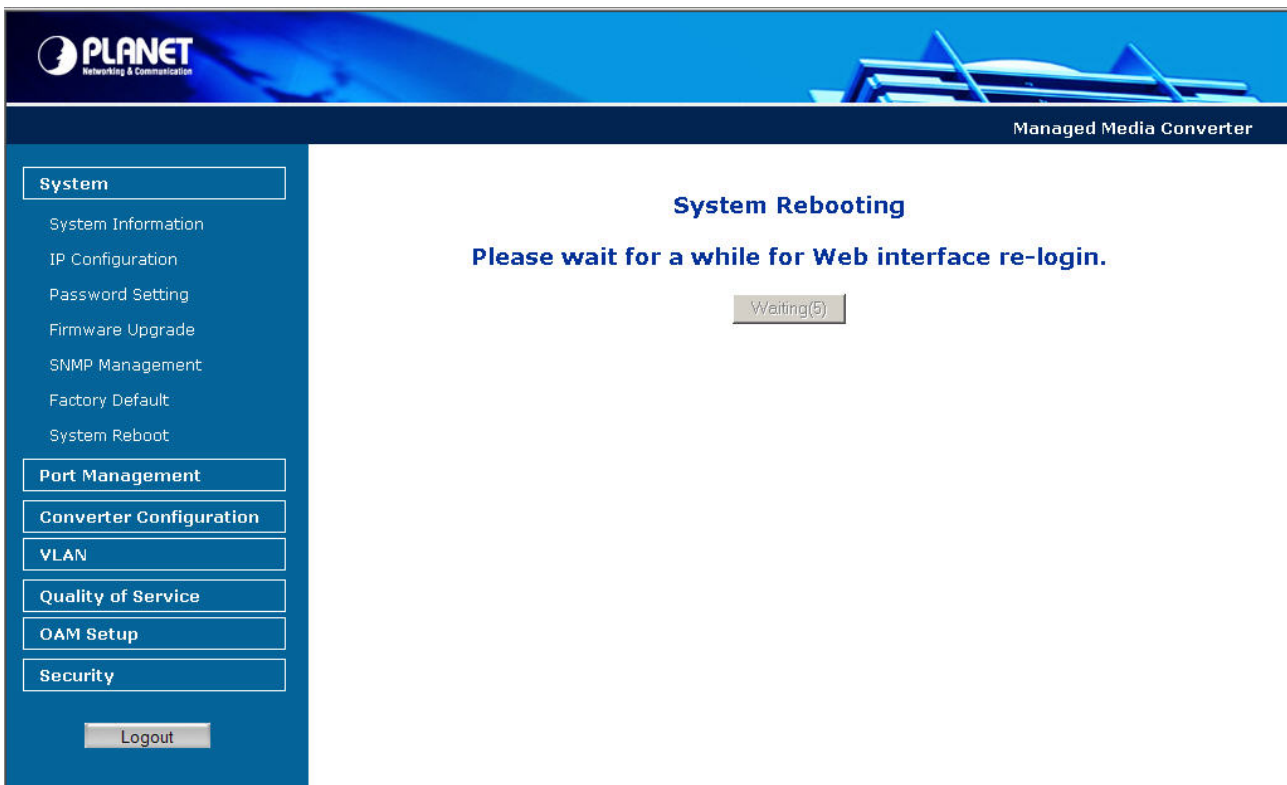

Figure 4-15 Factory Default Web page screen

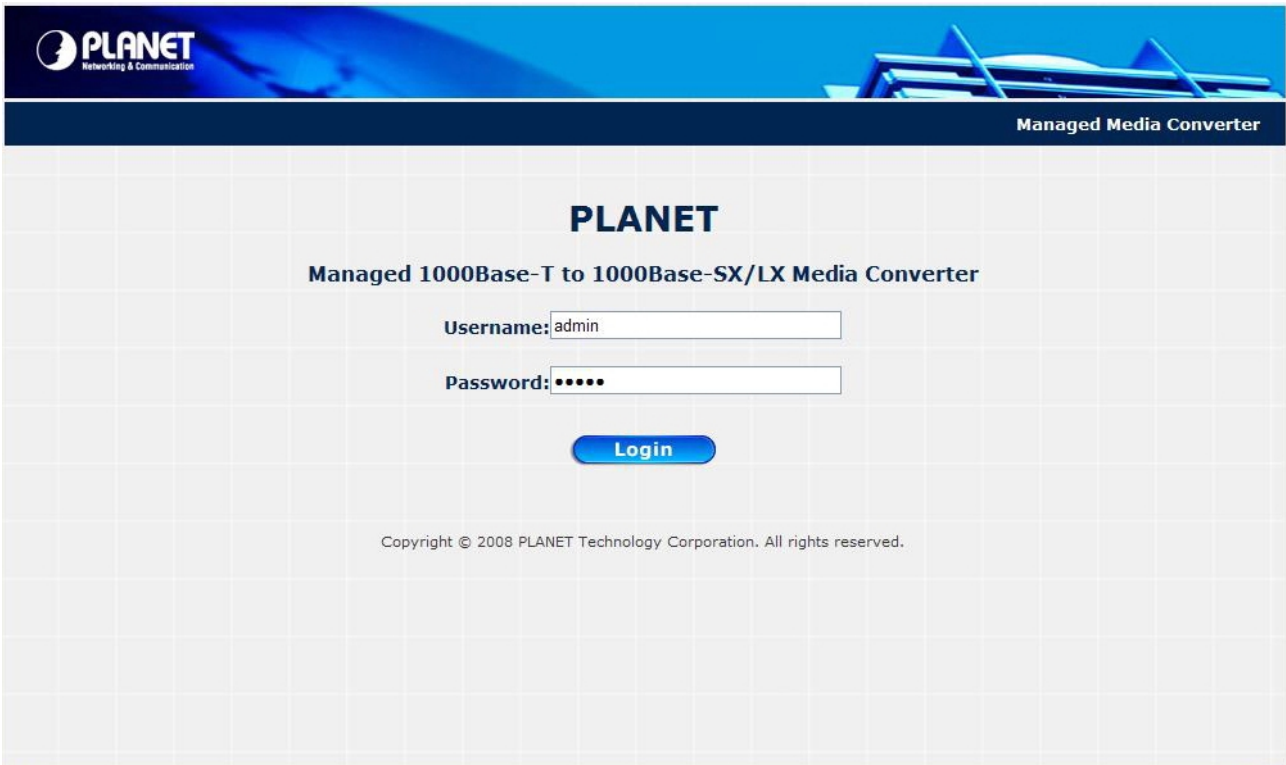

Figure 4-16 Login Web page screen

4.2.7 System Reboot

This function provides System Reboot function of the Managed Media Converter and the screen in Figure 4-17 & 4-18 & 4-19 appears.

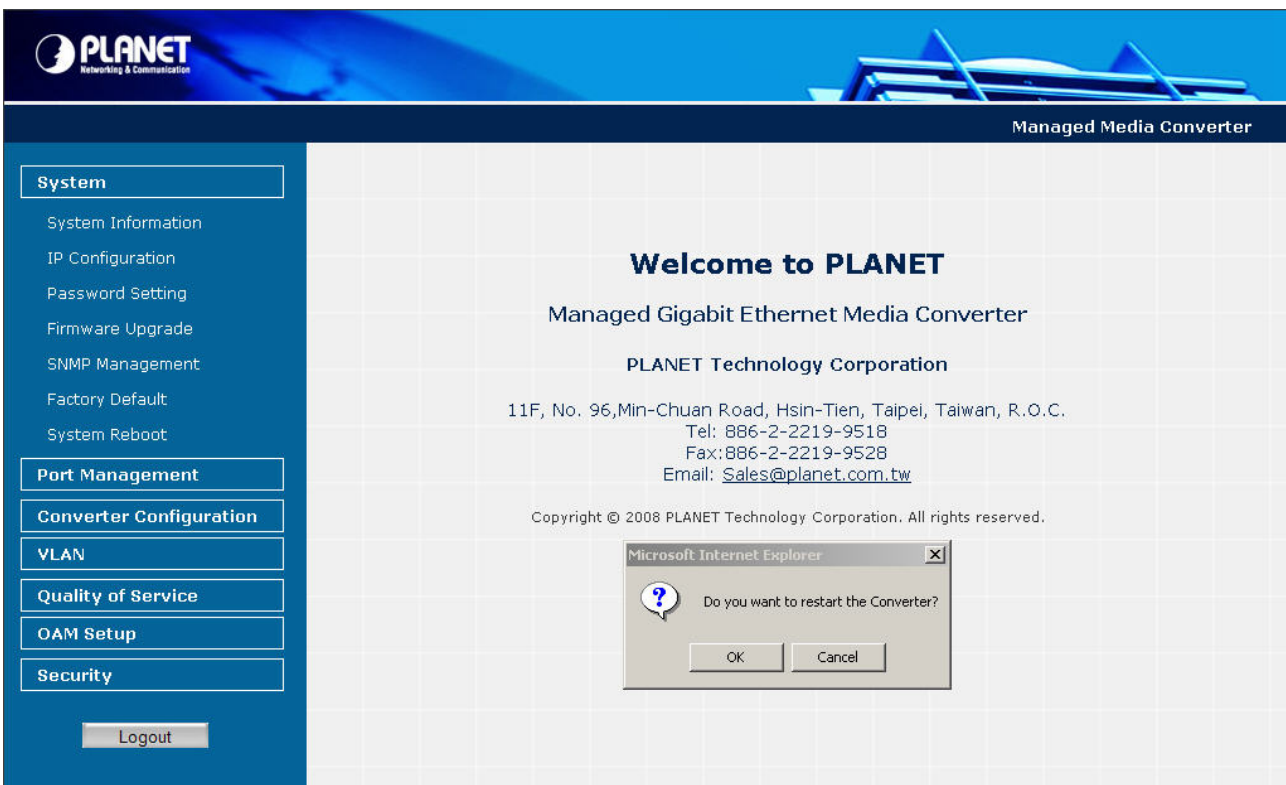

Figure 4-17 System Reboot Web page screen

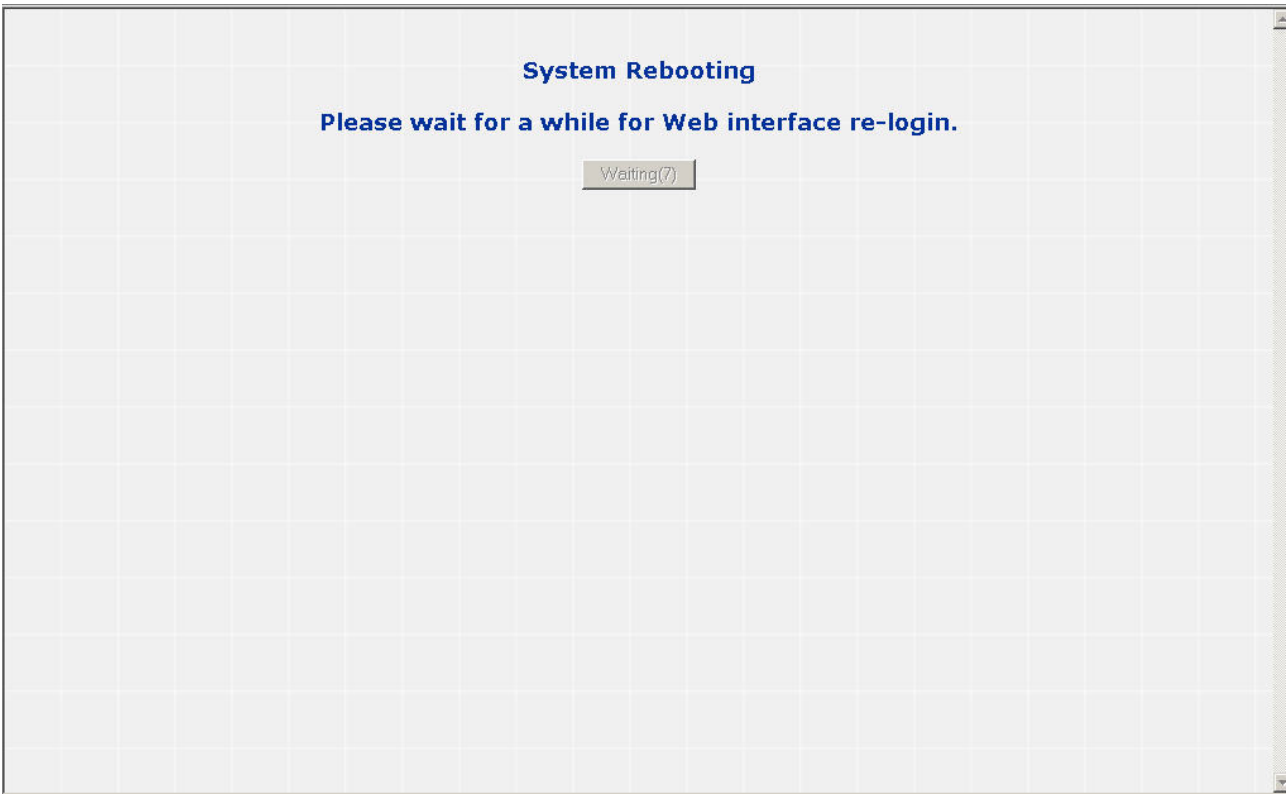

Figure 4-18 System Reboot Web page screen

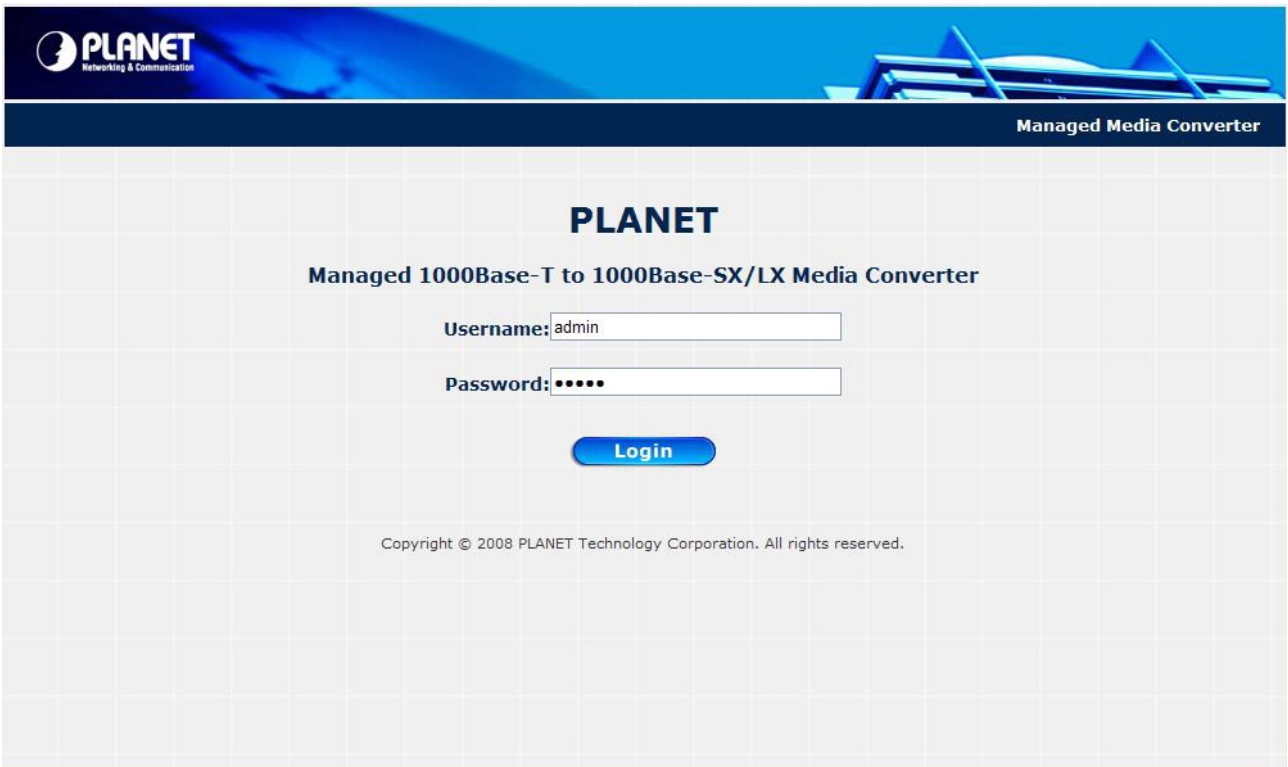

Figure 4-19 Login Web page screen

4.3 Port Management

4.3.1 Port Configuration

This function allows displaying TP / Fiber port status. The Link Status in the screen displays the current connection speed and duplex mode; else this function will show red “Down” when the TP / Fiber port is disconnected. Press the “Refresh” button to renew the screen. The screen in Figure 4-20 appears and Table 4-6 describes the Port Configuration object of Managed Media Converter.

Port	Link	Mode	Flow Control	Ingress Rate Limit	Egress Shaping
TP	100F	Auto Speed	Disabled	No Limit	No Limit
Fiber	Down	Auto Speed	Disabled	No Limit	No Limit

Figure 4-20 Port Configuration Web Page screen

The Port Configuration Web page includes the following configurable data:

Port	Indicate the TP port and Fiber port.
Link	Displays the current connection speed and duplex mode of TP or Fiber port.
Mode	<p>Allow configuring the TP or Fiber port speed and operation mode. Draw the menu bar to select the mode.</p> <p>TP Port:</p> <ul style="list-style-type: none"> • Auto Speed - Setup Auto negotiation. • 1000 Full - Force sets 1000Mbps Full-Duplex mode. • 100 Full - Force sets 100Mbps Full-Duplex mode. • 100 Half - Force sets 100Mbps Half-Duplex mode. • 10 Full - Force sets 10Mbps Full-Duplex mode. • 10 half - Force sets 10Mbps Half-Duplex mode. <p>Default mode: Auto Speed.</p> <p>Fiber Port:</p> <ul style="list-style-type: none"> • Auto Speed - Setup Auto negotiation. • 1000 Full - Force sets 1000Mbps Full-Duplex mode. <p>Default mode: Auto Speed.</p>

Flow Control	<p>Allow Disable or Enable Flow Control of TP or Fiber port.</p> <ul style="list-style-type: none"> • Enable – IEEE 802.3x Flow Control is enabled on Full-Duplex mode or Backpressure is enabled on Half-Duplex mode • Disable – No Flow Control or backpressure function on no matter Full-Duplex or Half-Duplex mode <p>Default mode: Disable</p>
Ingress Rate Limit	<p>The value of inbound traffic limitation in kilobit-per-second (kbps). The available options are :</p> <ul style="list-style-type: none"> • No Limit • 512K • 1M • 2M • 4M • 8M • 10M • 50M • 100M • 500M <p>Default mode: No Limit</p> <p>The Ingress Rate Limit configuration field as show in Figure 4-21.</p>
Egress Shaping	<p>The value of outbound traffic limitation in kilobit-per-second (kbps). The available options are :</p> <ul style="list-style-type: none"> • No Limit • 512K • 1M • 2M • 4M • 8M • 10M • 50M • 100M • 500M <p>Default mode: No Limit</p> <p>The Egress Shaping configuration field as show in Figure 4-22.</p>
Apply button	Press this button for save current configuration of Managed Media Converter.
Refresh button	Press “ Refresh ” button to refresh current status.

Table 4-6 Descriptions of the Port Configuration Web Page Screen Objects

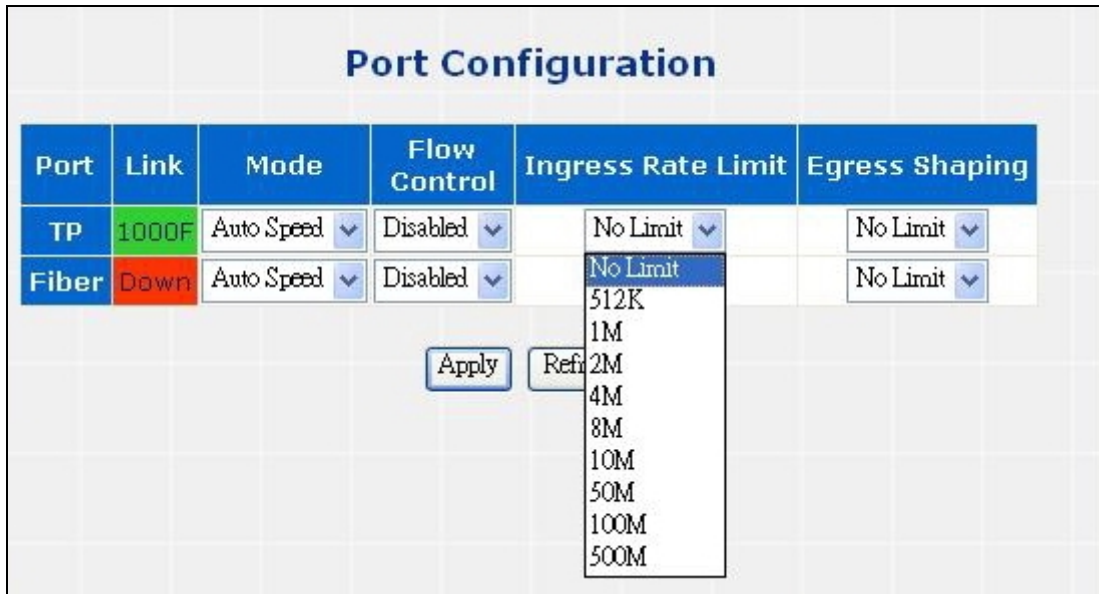

Figure 4-21 Port Configuration-Ingress Rate Limit Web Page screen

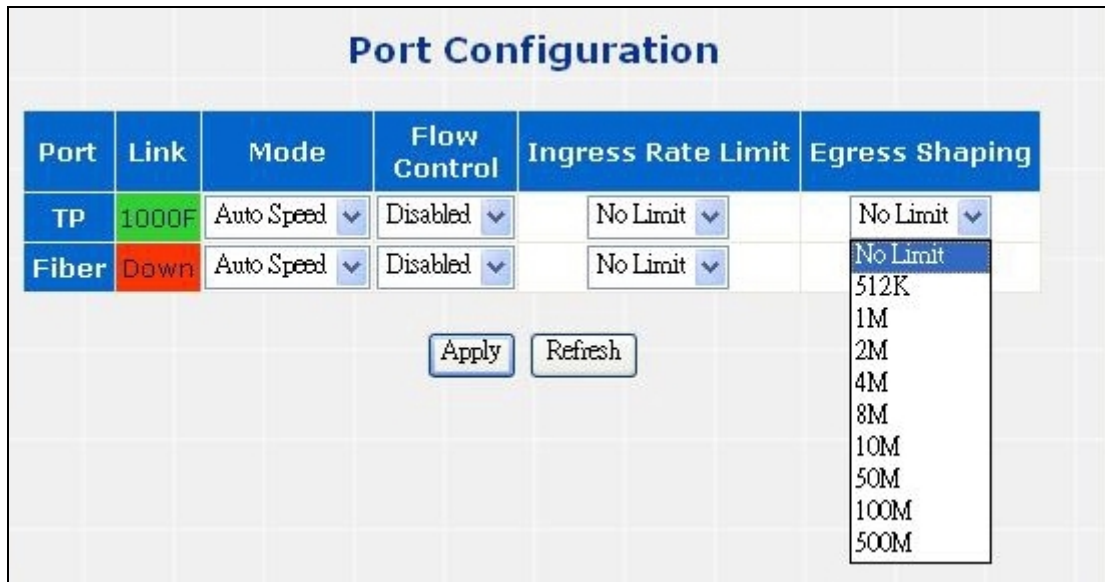

Figure 4-22 Port Configuration-Egress Shaping Web Page screen

4.3.2 Port Status

This function allows displaying TP / Fiber port detail status, such as Link Status, Duplex Mode, Flow control, Speed and Auto negotiation. Press the “Refresh” button to renew the screen, the screen in [Figure 4-23](#) appears and [Table 4-7](#) describes the Port Status object of Managed Media Converter.

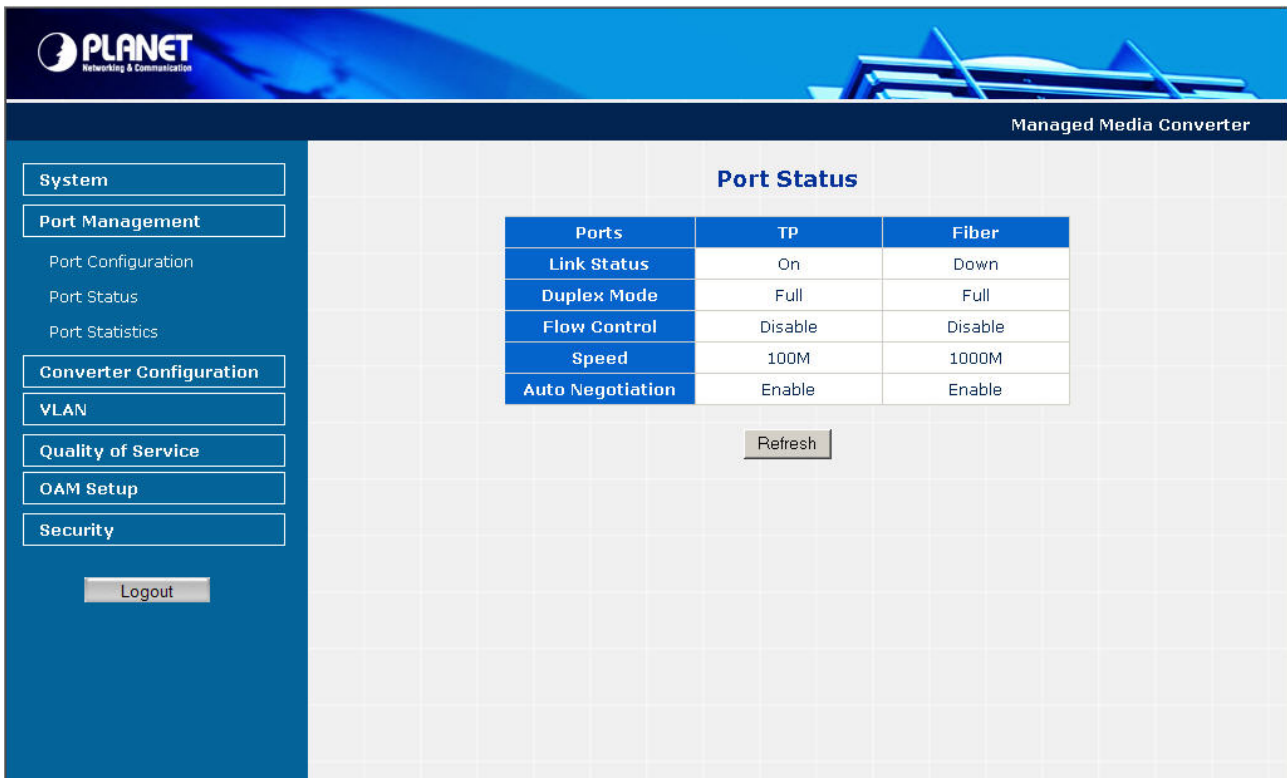

Figure 4-23 Port Status Web Page screen

The Port Status Web page includes the following configurable data:

Port	Indicate the TP port and Fiber port.
Link Status	Displays the current link status of TP and Fiber port.
Duplex Mode	Displays the current duplex mode of TP and Fiber port.
Flow Control	Displays the current Flow Control status of TP and Fiber port.
Speed	Displays the current speed mode of TP and Fiber port.
Auto Negotiation	Displays the current Auto negotiation status of TP and Fiber port.
Refresh button	Press “Refresh” button to refresh current status.

Table 4-7 Descriptions of the Port Status Web Page Screen Objects

4.3.3 Port Statistics

This function allows displaying TP / Fiber port detail Statistics, press the “Clear” button to clear current counter information. Press the “Refresh” button to renew the screen, the screen in Figure 4-24 & 4-25 appears.

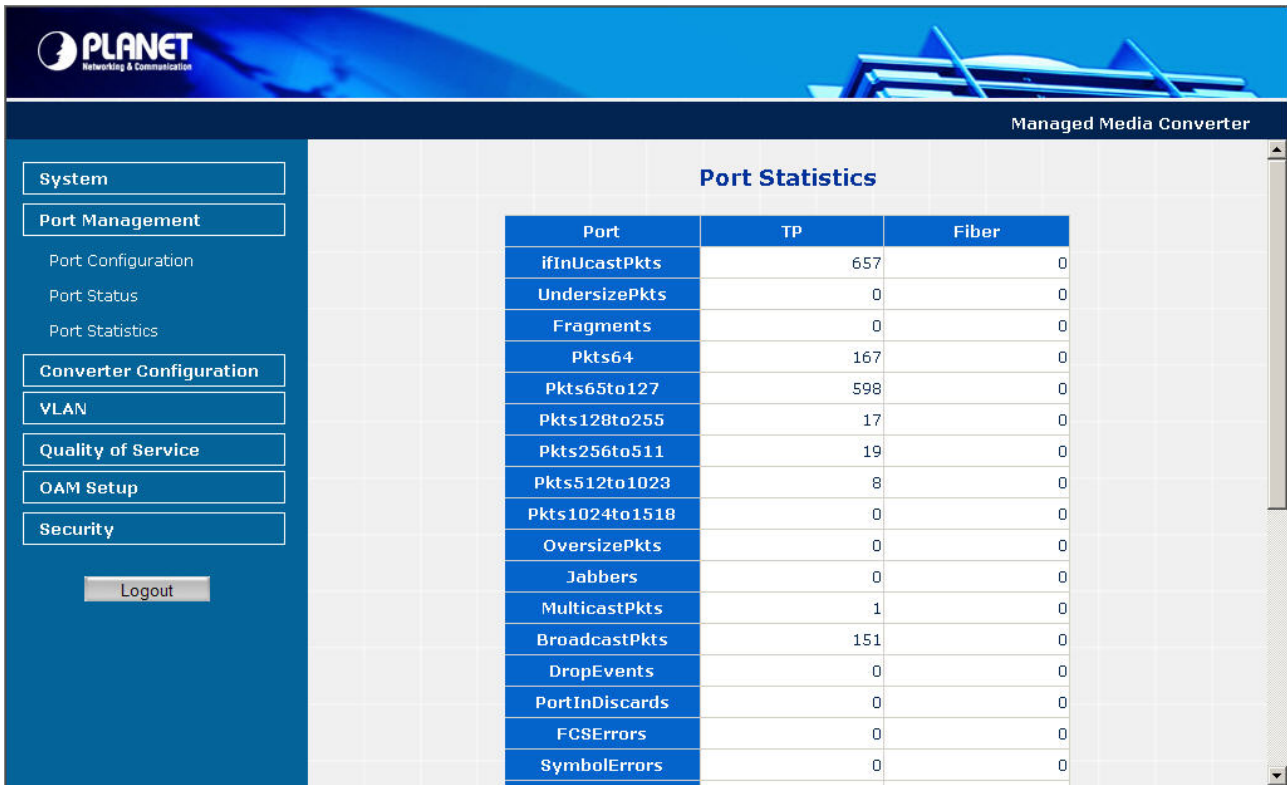

Figure 4-24 Port Statistics Web Page screen

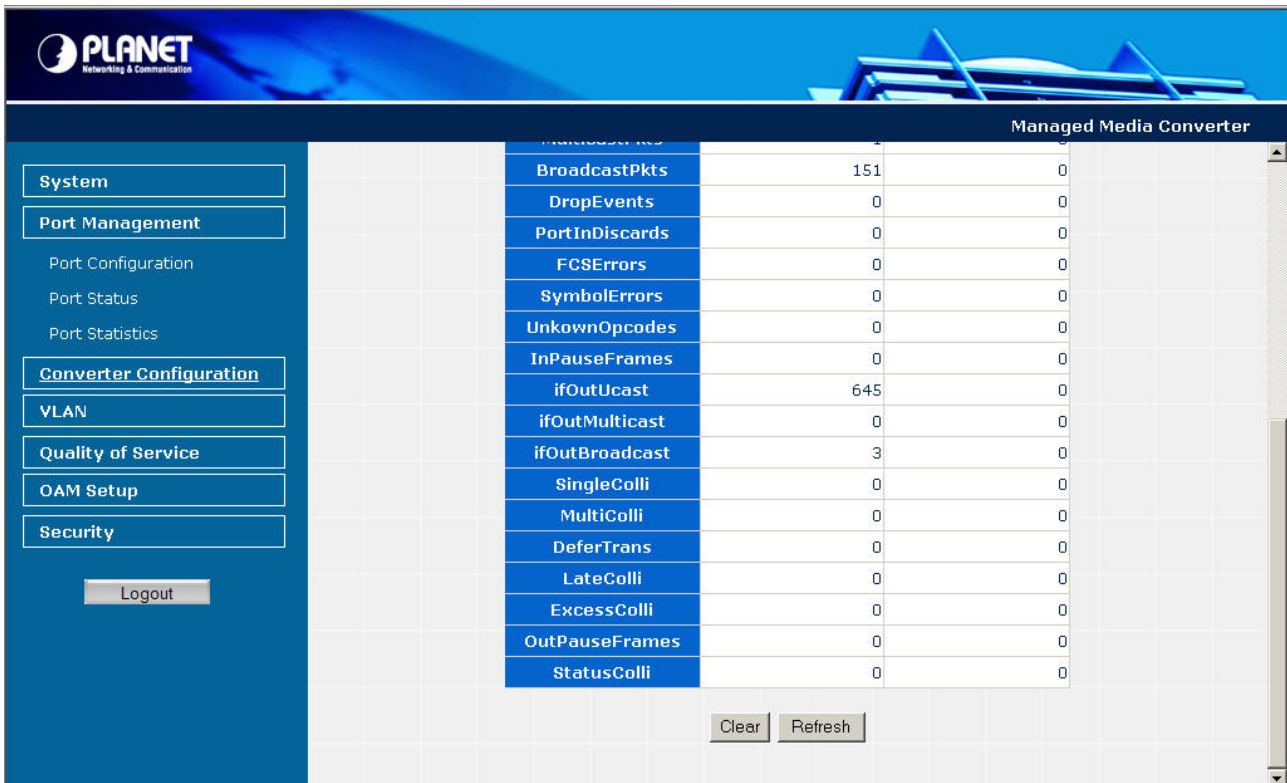

Figure 4-25 Port Statistics Web Page screen

4.4 Converter Configuration

This function provides useful setting for the Managed Media Converter, such as Maximum Packet length, Loop detection, storm control and etc. The screen in [Figure 4-26](#) appears and [Table 4-8](#) describes the Converter Configuration object of Managed Media Converter.

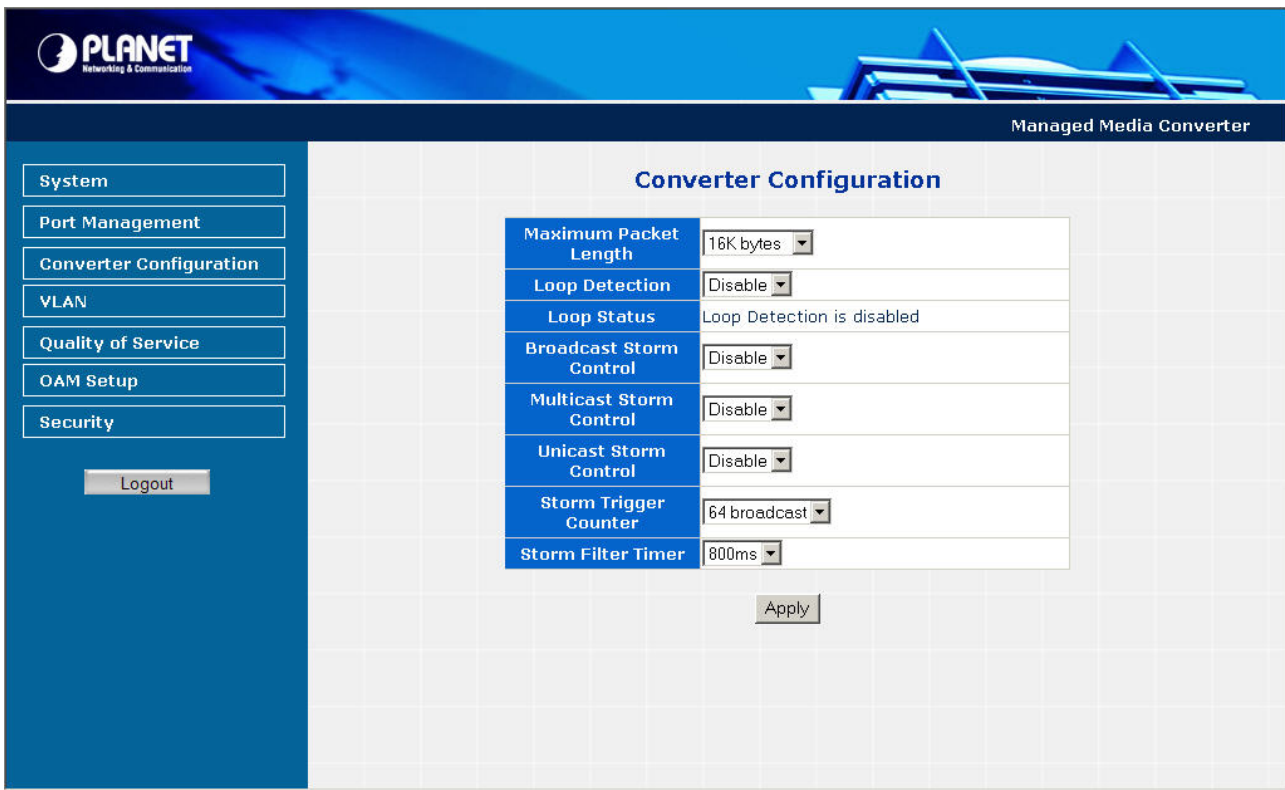

Figure 4-26 Converter Configuration Web Page screen

The Converter Configuration Web page includes the following configurable data:

Maximum Packet Length	Provide maximum packet length setting for the Managed Media Converter, the available options are 1518 bytes, 2048 bytes and 16K bytes. Default mode is 16K bytes .
Loop Detection	Provide Disable or enable the Loop detection function. Default mode is Disable .
Loop Status	Displays the Loop Detection status.
Broadcast Storm Control	Provide Disable or enable the Broadcast Storm Control function. Default mode is Disable .
Multicast Storm Control	Provide Disable or enable the Multicast Storm Control function. Default mode is Disable .
Unicast Storm Control	Provide Disable or enable the Unicast Storm Control function. Default mode is Disable .
Storm Trigger Counter	Provide storm Trigger Counter setting and the available options are: 64 broadcast 32 broadcast 16 broadcast 8 broadcast Default mode is 64 broadcast .

Storm Filter Timer	Provide storm Filter Timer setting and the available options are: 800ms 400ms 200ms 100ms Default mode is 800ms .
Apply button	Press this button for save current configuration of Managed Media Converter.

Table 4-8 Descriptions of the Converter Configuration Web Page Screen Objects

4.5 VLAN

A Virtual LAN (VLAN) is a logical network grouping that limits the broadcast domain. It allows you to isolate network traffic so only members of the VLAN receive traffic from the same VLAN members. Basically, creating a VLAN from a converter is logically equivalent of reconnecting a group of network devices to another Layer 2 switch. However, all the network devices are still plug into the same switch physically.

The Managed Media Converter supports IEEE 802.1Q (tagged-based) VLAN setting in web management page. In the default configuration, VLAN support is “**No VLAN**”.

IEEE 802.1Q VLANs

IEEE 802.1Q (tagged) VLAN are implemented on the Managed Media Converter. 802.1Q VLAN require tagging, which enables them to span the entire network (assuming all devices on the network are IEEE 802.1Q-compliant).

VLAN allow a network to be segmented in order to reduce the size of broadcast domains. All packets entering a VLAN will only be forwarded to the stations (over IEEE 802.1Q enabled switches) that are members of that VLAN, and this includes broadcast, multicast and unicast packets from unknown sources.

VLAN can also provide a level of security to your network. IEEE 802.1Q VLAN will only deliver packets between stations that are members of the VLAN. Any port can be configured as either tagging or untagging. The untagging feature of IEEE 802.1Q VLAN allows VLAN to work with legacy switches that don't recognize VLAN tags in packet headers. The tagging feature allows VLAN to span multiple 802.1Q-compliant switches through a single physical connection and allows Spanning Tree to be enabled on all ports and work normally.

Any port can be configured as either tagging or untagging. The untagging feature of IEEE 802.1Q VLAN allows VLAN to work with legacy switches that don't recognize VLAN tags in packet headers. The tagging feature allows VLAN to span multiple 802.1Q-compliant switches through a single physical connection and allows Spanning Tree to be enabled on all ports and work normally.

Some relevant terms:

Tag - The act of putting 802.1Q VLAN information into the header of a packet.

Untag - The act of stripping 802.1Q VLAN information out of the packet header.

802.1Q VLAN Tags

The figure below shows the 802.1Q VLAN tag. There are four additional octets inserted after the source MAC address. Their presence is indicated by a value of 0x8100 in the Ether Type field. When a packet's Ether Type field is equal to 0x8100, the packet carries the IEEE 802.1Q/802.1p tag. The tag is contained in the following two octets and consists of 3 bits of user priority, 1 bit of Canonical Format Identifier (CFI - used for encapsulating Token Ring packets so they can be carried across Ethernet backbones), and 12 bits of VLAN ID (VID). The 3 bits of user priority are used by 802.1p. The VID is the VLAN identifier and is used by the 802.1Q standard. Because the VID is 12 bits long, 4094 unique VLAN can be identified.

The tag is inserted into the packet header making the entire packet longer by 4 octets. All of the information originally contained in the packet is retained.

802.1Q Tag

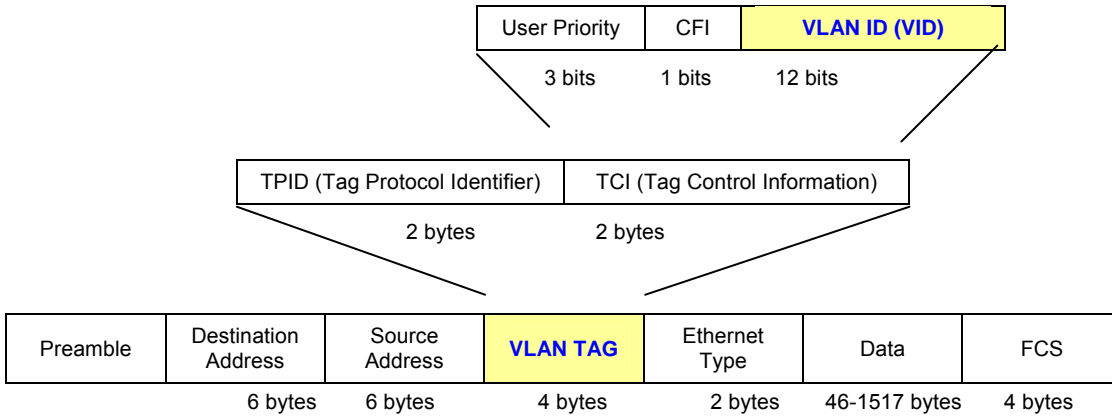

The Ether Type and VLAN ID are inserted after the MAC source address, but before the original Ether Type/Length or Logical Link Control. Because the packet is now a bit longer than it was originally, the Cyclic Redundancy Check (CRC) must be recalculated.

Adding an IEEE802.1Q Tag

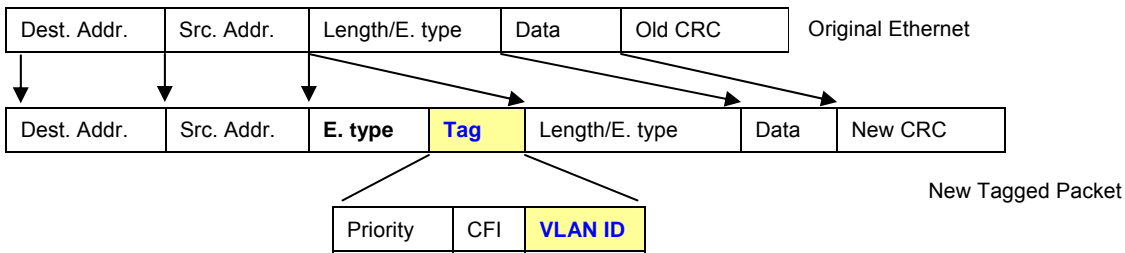

Port VLAN ID

Packets that are tagged (are carrying the 802.1Q VID information) can be transmitted from one 802.1Q compliant network device to another with the VLAN information intact. This allows 802.1Q VLAN to span network devices (and indeed, the entire network – if all network devices are 802.1Q compliant).

Every physical port on a switch has a PVID. 802.1Q ports are also assigned a PVID, for use within the switch. If no VLAN are defined on the switch, all ports are then assigned to a default VLAN with a PVID equal to 1. Untagged packets are assigned the PVID of the port on which they were received. Forwarding decisions are based upon this PVID, in so far as VLAN are concerned. Tagged packets are forwarded according to the VID contained within the tag. Tagged packets are also assigned a PVID, but the PVID is not used to make packet forwarding decisions, the VID is.

Tag-aware switches must keep a table to relate PVID within the switch to VID on the network. The switch will compare the VID of a packet to be transmitted to the VID of the port that is to transmit the packet. If the two VID are different the switch will drop the packet. Because of the existence of the PVID for untagged packets and the VID for tagged packets, tag-aware and tag-unaware network devices can coexist on the same network.

A switch port can have only one PVID, but can have as many VID as the switch has memory in its VLAN table to store them.

Because some devices on a network may be tag-unaware, a decision must be made at each port on a tag-aware device before packets are transmitted – should the packet to be transmitted have a tag or not? If the transmitting port is connected to a tag-unaware device, the packet should be untagged. If the transmitting port is connected to a tag-aware device, the packet should be tagged.

Default VLANs

The Managed Media Converter initially configures one VLAN, VID = 1, called "**default**." The factory default setting assigns all ports on the Managed Media Converter to the "**default**". As new VLAN are configured in Port-based mode, their respective member ports are removed from the "**default**."

4.5.1 VLAN Group

This function allows disable or enable the IEEE 802.1Q VLAN operation mode. Press the "**Apply**" button to save the current configuration of Managed Media Converter. The screen in [Figure 4-27 & 4-28](#) appears and [Table 4-9](#) describes the VLAN Group object of Managed Media Converter.

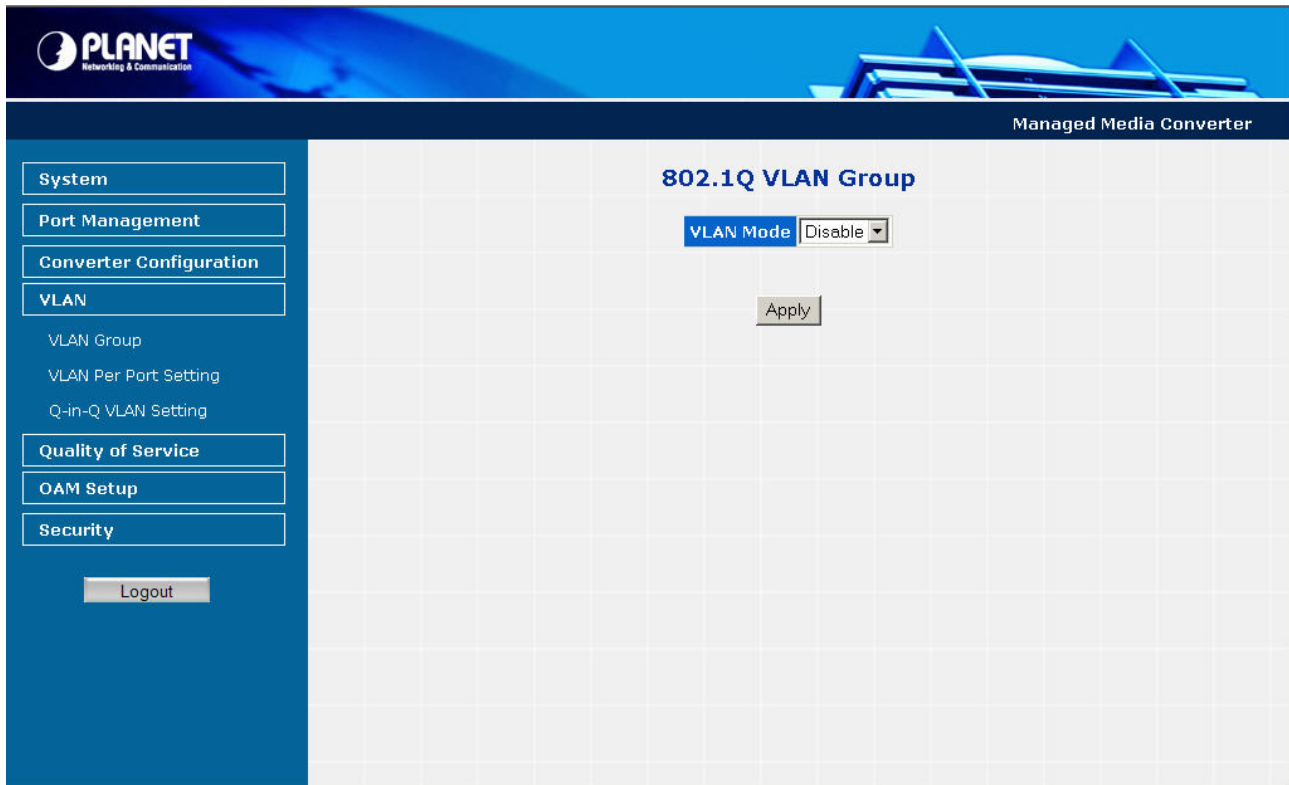

Figure 4-27 VLAN Group Web Page screen

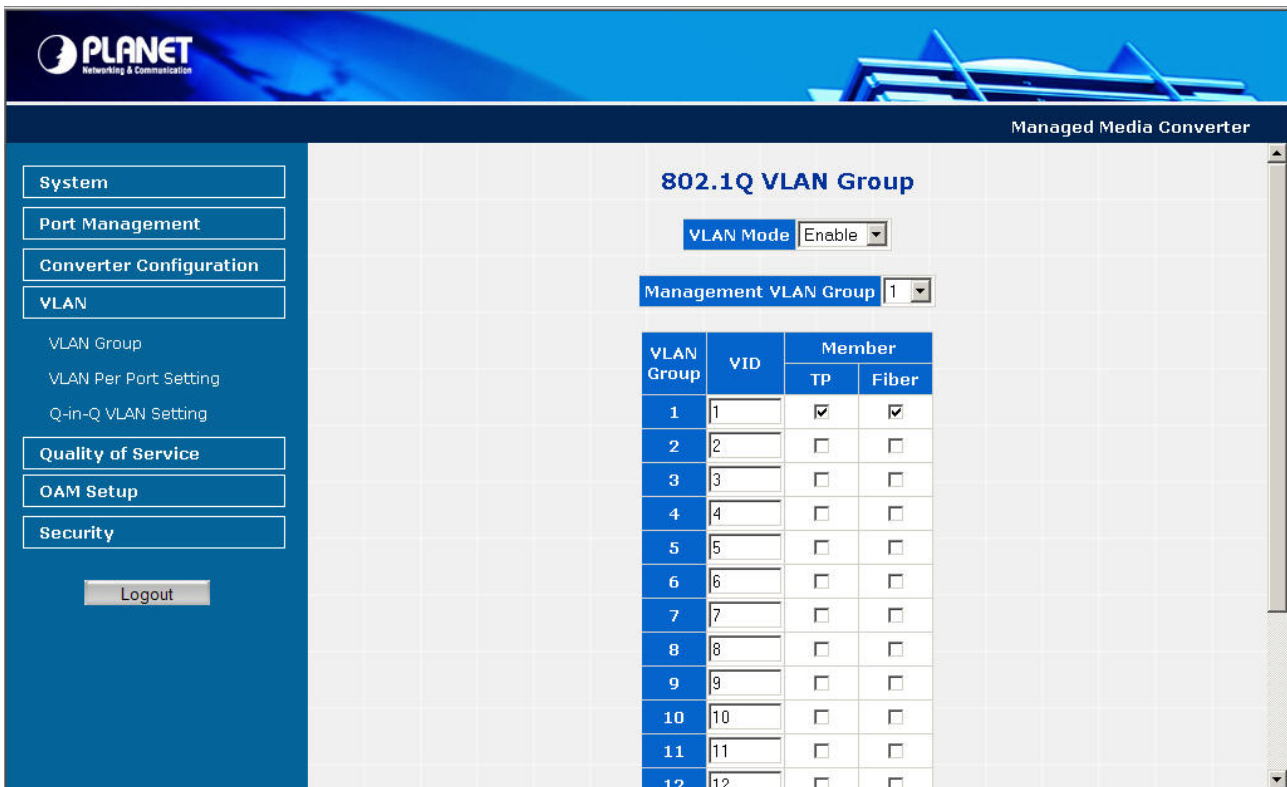

Figure 4-28 VLAN Group Web Page screen

The VLAN Group Web page includes the following configurable data:

VLAN Mode	Provide Disable or enable the IEEE 802.1Q VLAN operation mode. Default mode is Disable .	
Management VLAN Group	Provide define the Management VLAN group. Default mode is VLAN1 .	
VLAN Group	Indicate the VLAN Group from 1 to 16.	
VID	Provide define the VLAN Group ID and the available options are 1 to 4094 .	
Member	TP	Provide assign TP port into VLAN Groups.
	Fiber	Provide assign Fiber port into VLAN Groups.
Apply button	Press this button for save current configuration of Managed Media Converter.	

Table 4-9 Descriptions of the VLAN Group Web Page Screen Objects

Notice: When change the Management VLAN Group setting, please assure the TP or fiber port that connect to administrator PC is in the same VLAN Group, otherwise, for further managed is impossible. The only solution is press the reset button 10 seconds for system reset to default mode.

4.5.2 VLAN Per Port Setting

This function provides IEEE 802.1Q VLAN per port setting for TP and Fiber port of Managed Media Converter. Press the “Apply” button to save the current configuration of Managed Media Converter. The screen in [Figure 4-29](#) appears and [Table 4-10](#) describes the VLAN Per Port Setting object of Managed Media Converter.

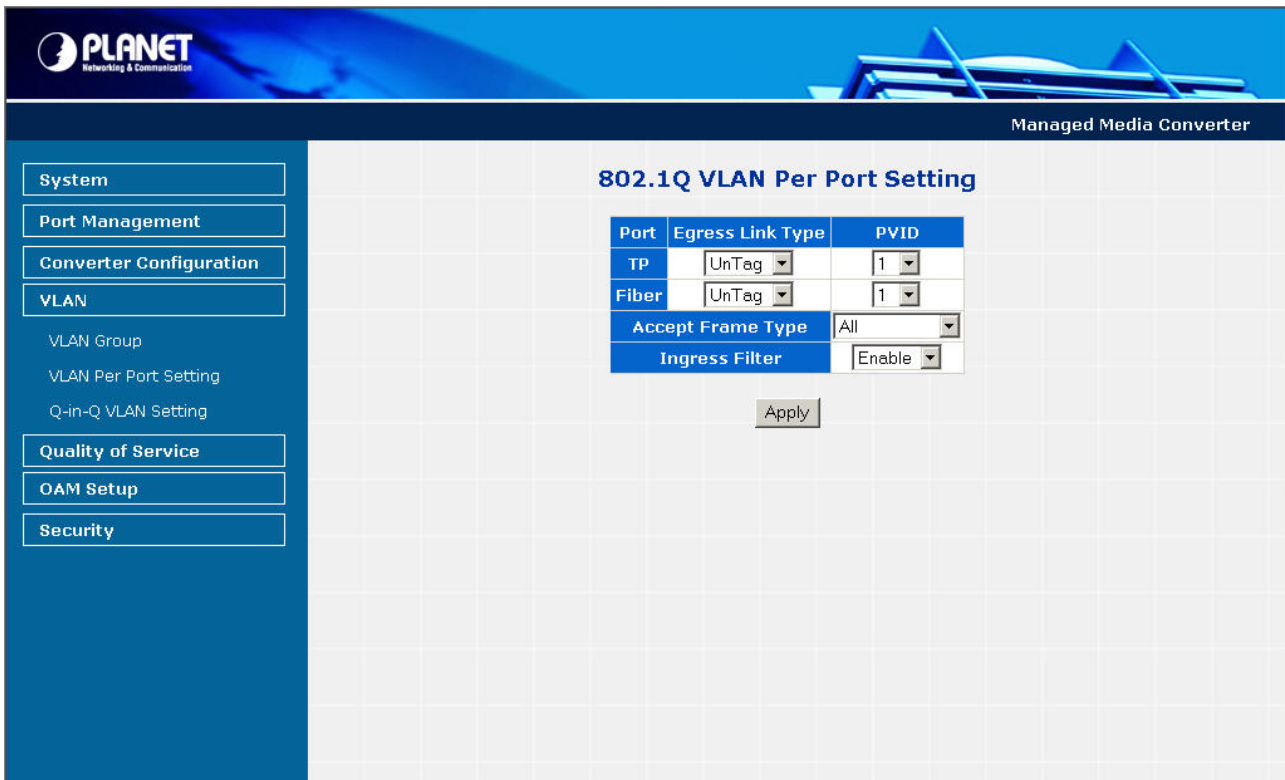

Figure 4-29 VLAN Per Port Setting Web Page screen

The VLAN Per Port Setting Web page includes the following configurable data:

Port	Indicate the TP port and Fiber port.
Egress Link Type	Provide Egress Link Type options for TP port and Fiber port, the available options are: UnTag Tag ByPass Default mode is UnTag .
PVID	Provide PVID assign for TP port and Fiber port, the available options are 1 to 4094. Default mode is 1 to 16 .
Accept Frame Type	Provide define the Accept Frame Type and the available options are All Tagged Only Default mode is All .
Ingress Filter	Provide disable or enable the Ingress Filter function. Default mode is Enable .
Apply button	Press this button for save current configuration of Managed Media Converter.

Table 4-10 Descriptions of the VLAN Per Port Setting Web Page Screen Objects

4.5.3 Q-in-Q VLAN Setting

When enable Q-in-Q function, Managed Media Converter can insert or remove 4-bytes Q-in-Q tag in the received 802.3 frames after SA. User can define Q-in-Q tag value freely. And in default condition, Q-in-Q tag format is same as VLAN tag. In normal application, enable two port's Q-in-Q function. UTP Port set to insert QinQ tag and Fiber port set to remove Q-in-Q Tag. For aggregation layer switch, it will check Q-in-Q tag only, not care about the VLAN tag from the corridor layer switch. Q-in-Q Tag ether type can be set same as VLAN tag ether type or other values.

This function provides IEEE 802.1Q Q-in-Q VLAN setting of Managed Media Converter. Press the “**Apply**” button to save the current configuration of Managed Media Converter. The screen in Figure 4-30 appears and Table 4-11 describes the Q-in-Q VLAN setting object of Managed Media Converter.

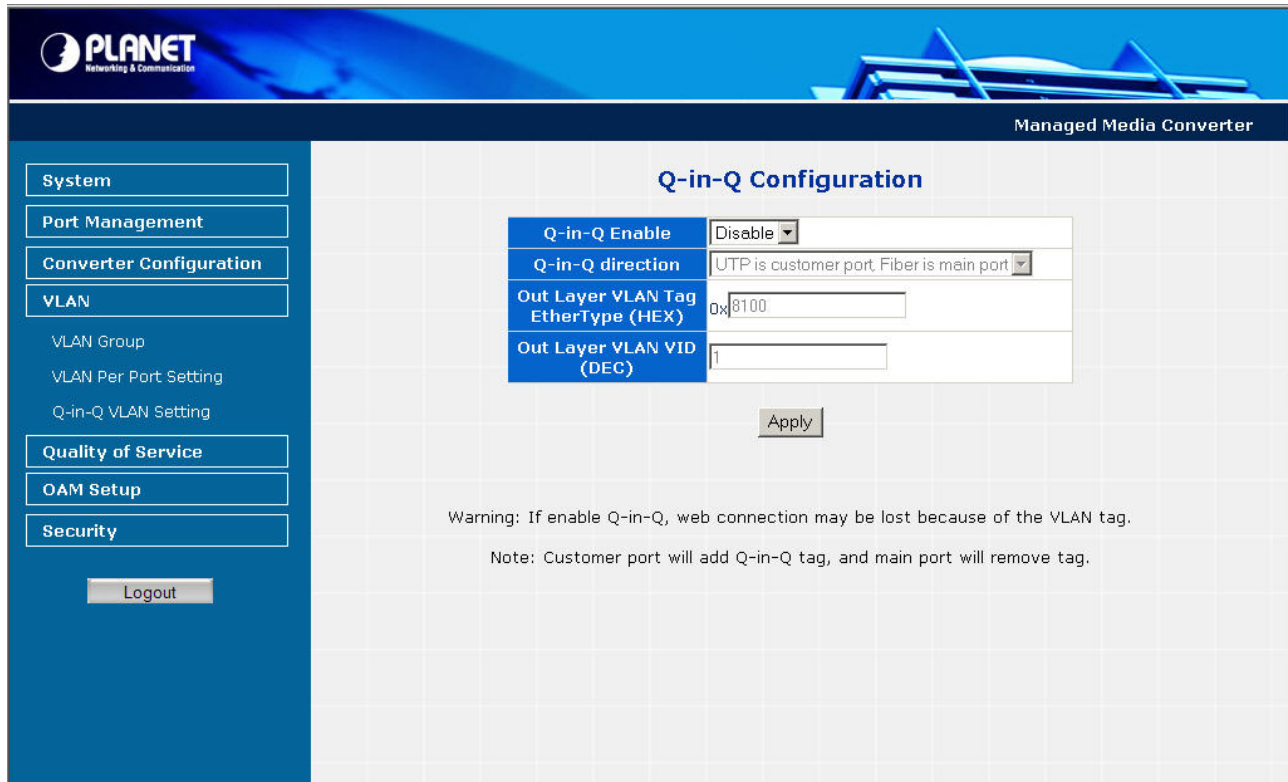

Figure 4-30 Q-in-Q VLAN setting Web Page screen

The Q-in-Q VLAN setting Web page includes the following configurable data:

Q-in-Q Enable	Provide disable or enable the Q-in-Q VLAN function. Default mode is Disable .
Q-in-Q direction	Provide two directions for Q-in-Q function, the available options are: UTP is customer port, Fiber is main port Fiber is customer port, UTP is main port Default mode is UTP is customer port, Fiber is main port .
Out Layer VLAN Tag EtherType (HEX)	Allow defined the Out Layer VLAN Tag EtherType and default mode is 0x8100 .
Out Layer VLAN VID (DEC)	Allow defined the Out Layer VLAN VID and default mode is 1 .
Apply button	Press this button for save current configuration of Managed Media Converter.

Table 4-11 Descriptions of the Q-in-Q VLAN setting Web Page Screen Objects

4.6 Quality of Service

Quality of Service (QoS) is an advanced traffic prioritization feature that allows you to establish control over network traffic. QoS enables you to assign various grades of network service to different types of traffic, such as multi-media, video, protocol-specific, time critical, and file-backup traffic.

QoS reduces bandwidth limitations, delay, loss, and jitter. It also provides increased reliability for delivery of your data and allows you to prioritize certain applications across your network. You can define exactly how you want the switch to treat selected applications and types of traffic.

You can use QoS on your system to:

- Control a wide variety of network traffic by:
- Classifying traffic based on packet attributes.
- Assigning priorities to traffic (for example, to set higher priorities to time-critical or business-critical applications).
- Applying security policy through traffic filtering.
- Provide predictable throughput for multimedia applications such as video conferencing or voice over IP by minimizing delay and jitter.
- Improve performance for specific types of traffic and preserve performance as the amount of traffic grows.
- Reduce the need to constantly add bandwidth to the network.
- Manage network congestion.

This function provides Quality of Service setting of Managed Media Converter. Press the “**Apply**” button to save the current configuration of Managed Media Converter. The screen in [Figure 4-31](#) appears and [Table 4-12](#) describes the Quality of Service object of Managed Media Converter.

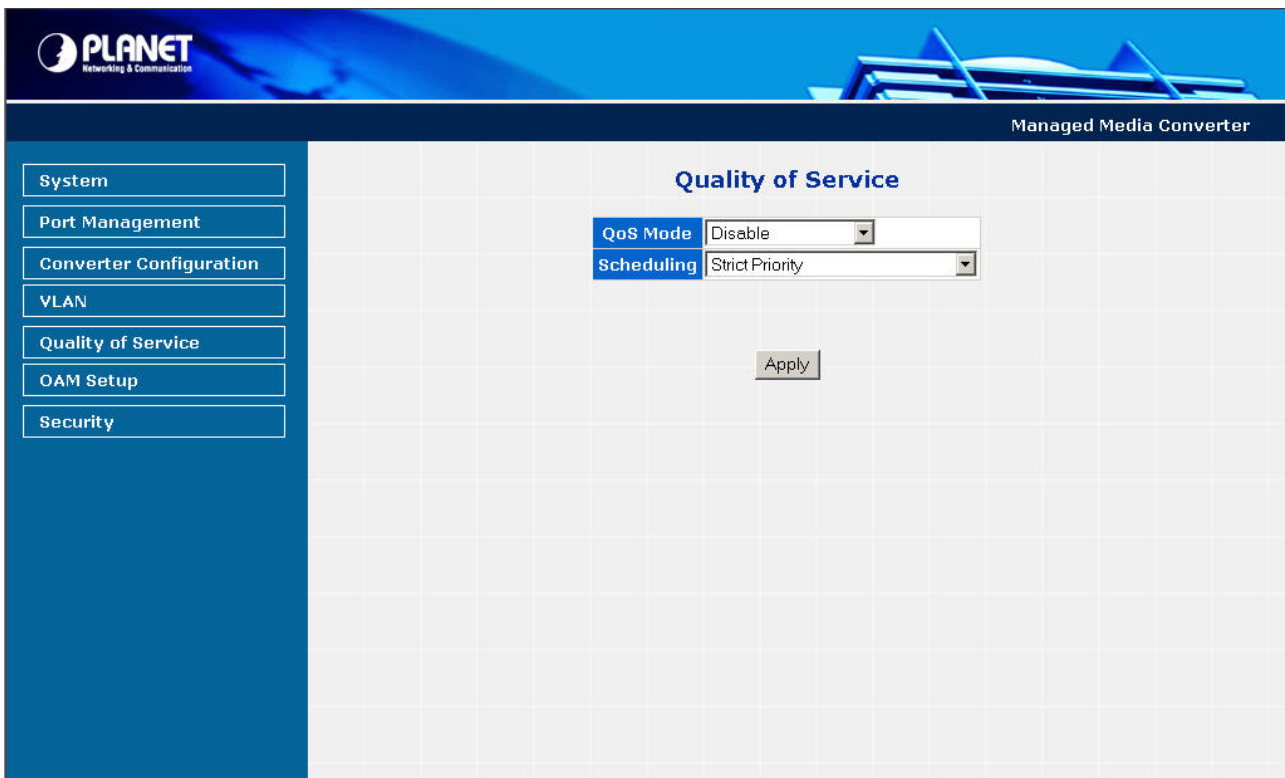

Figure 4-31 Quality of Service Web Page screen

The Quality of Service Web page includes the following configurable data:

Qos Mode	<p>Provide 4 different QoS mode for operation, the available options are:</p> <p>Disable</p> <p>802.1p Tag Priority</p> <p>The 802.1p Tag Priority field as show in Figure 4-32.</p> <p>IP Address Priority</p> <p>The IP Address Priority field as show in Figure 4-33.</p> <p>IP DSCP Priority</p> <p>The IP DSCP Priority field as show in Figure 4-34.</p> <p>Default mode is Disable.</p>
Scheduling	<p>Provide two scheduling method for Quality of Service, the available options are:</p> <p>Strict Priority</p> <p>Weighted Round Robin (16:8:4:1)</p> <p>Default mode is Strict Priority.</p>
Apply button	<p>Press this button for save current configuration of Managed Media Converter.</p>

Table 4-12 Descriptions of the Quality of Service Web Page Screen Objects

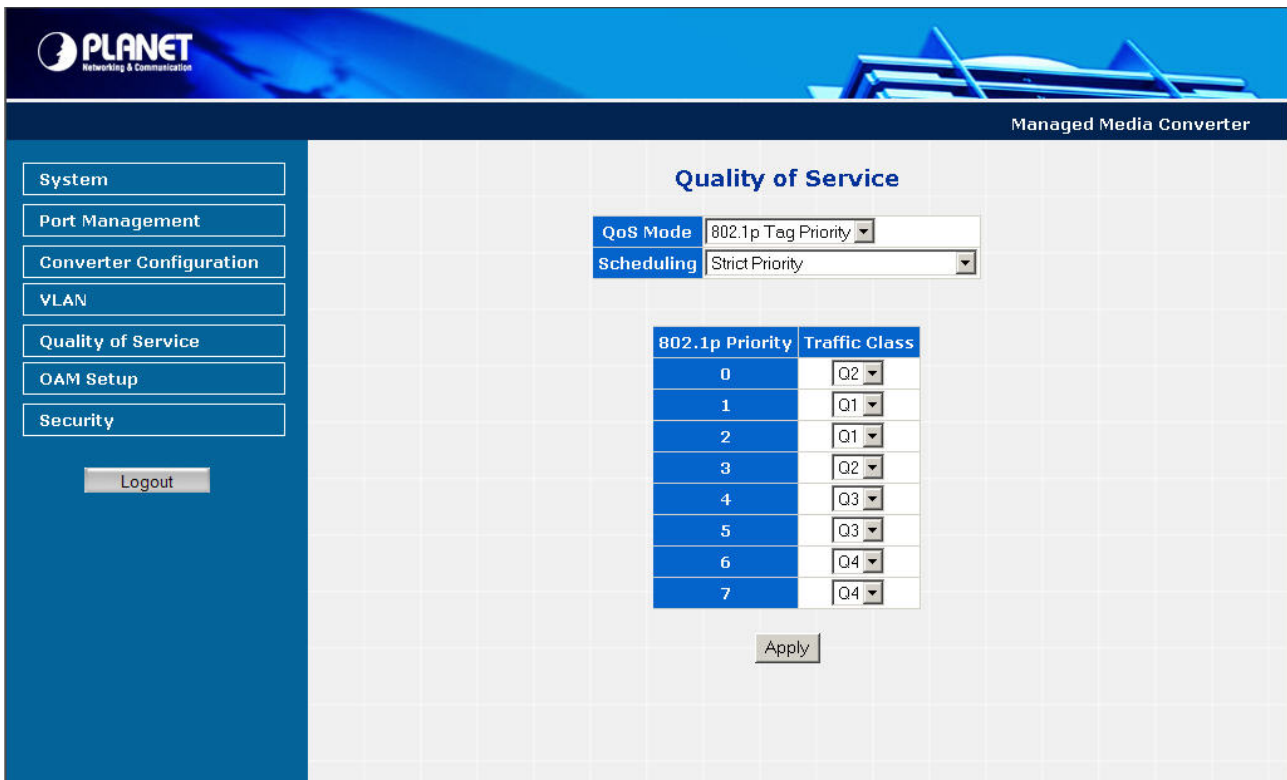

Figure 4-32 802.1p Tag Priority Web Page screen

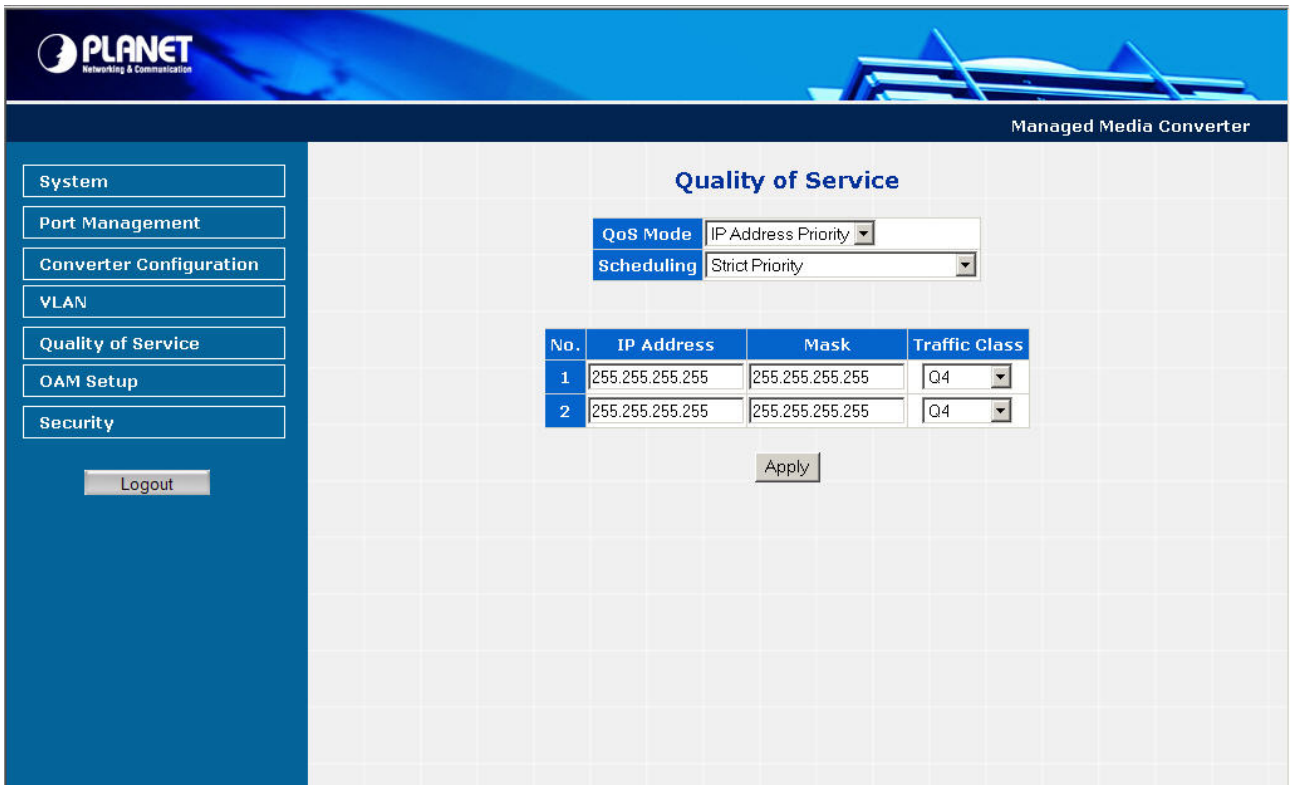

Figure 4-33 IP Address Priority Web Page screen

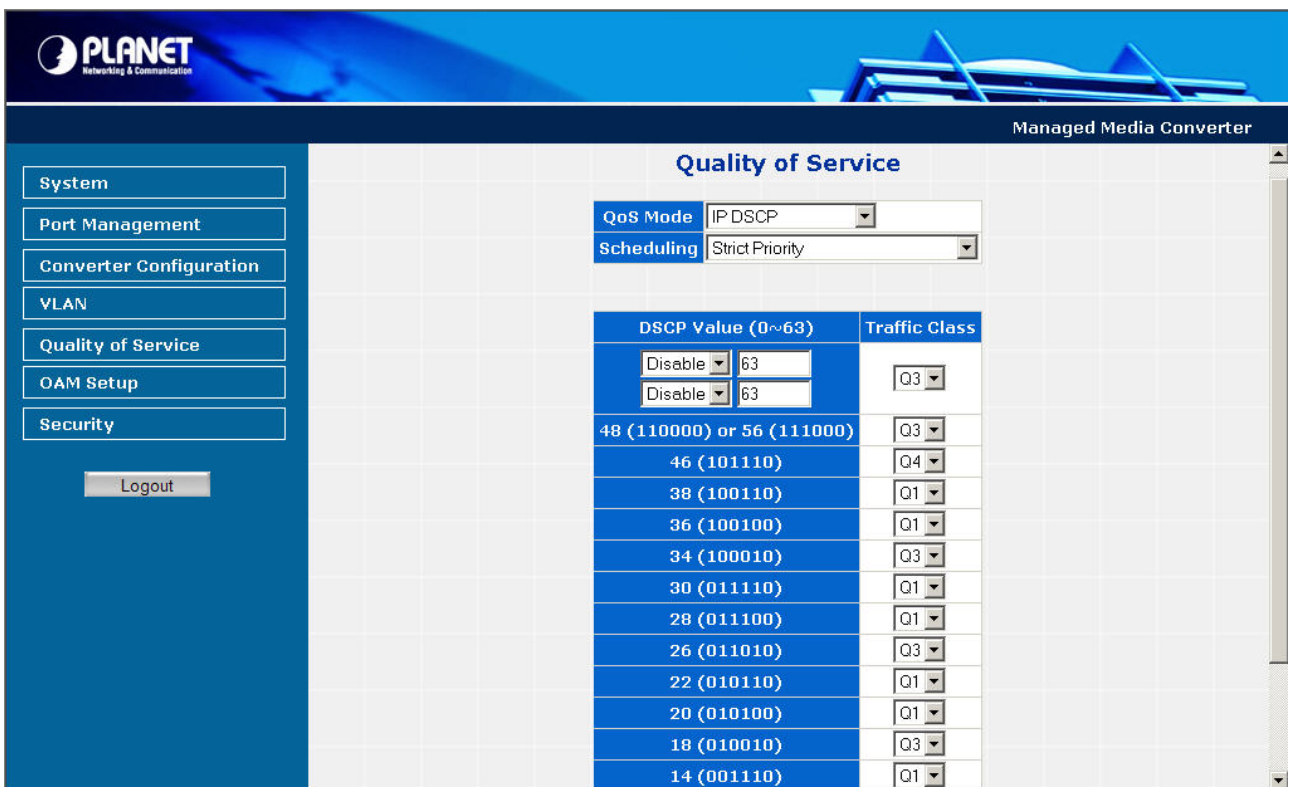

Figure 4-34 IP DSCP Priority Web Page screen

4.7 OAM Setup

4.7.1 Local TS-1000 OAM Setup

This function provides Local TS-1000 OAM Setup of Managed Media Converter. Press the “**Apply**” button to save the current configuration of Managed Media Converter. The screen in [Figure 4-35](#) appears and [Table 4-13](#) describes the Local TS-1000 OAM Setup object of Managed Media Converter.

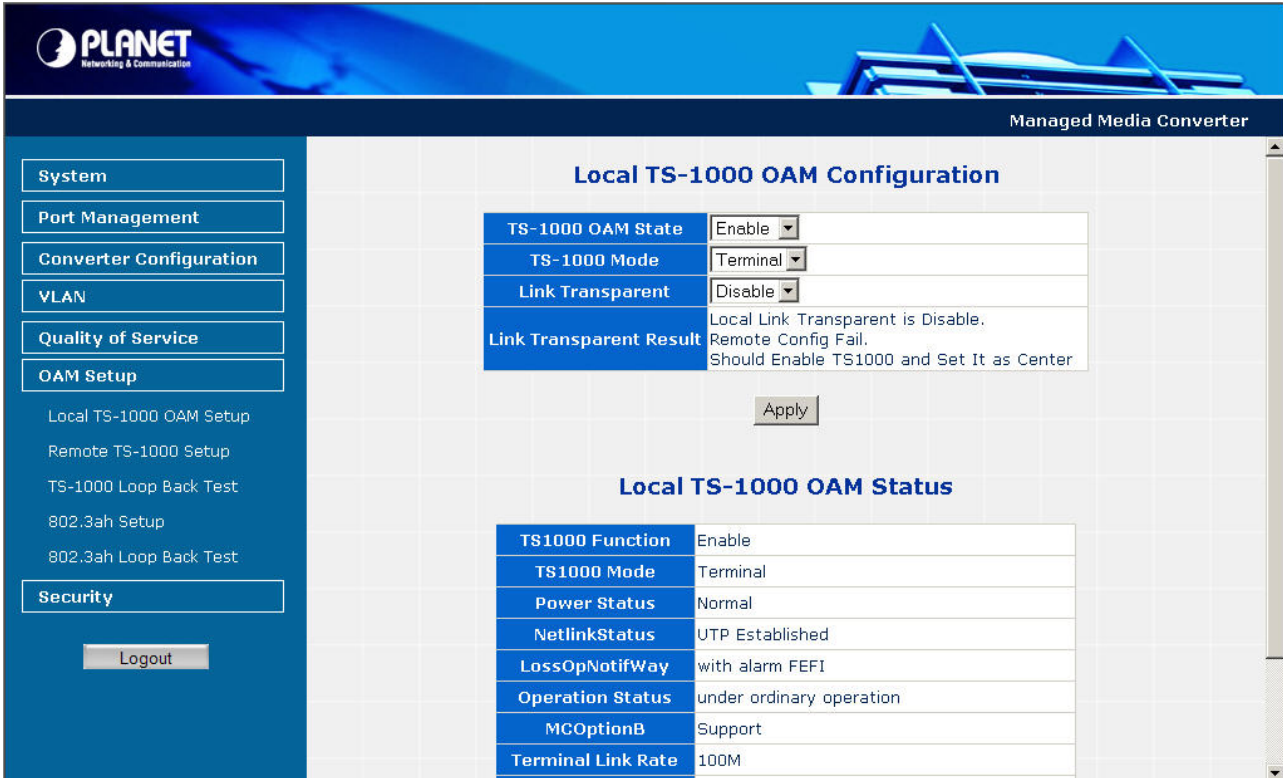

Figure 4-35 Local TS-1000 OAM Setup Web Page screen

The Local TS-1000 OAM Setup Web page includes the following configurable data:

TS-1000 OAM State	Provide disable or enable the TS-1000 OAM operation mode. Default mode is Disable .
TS-1000 Mode	Provide two TS-1000 modes for operation, the available options are: Terminal Center Default mode is Terminal .
Link Transparent	Provide disable or enable the Link Transparent function. Default mode is Disable .
Link Transparent Result	Display the link transparent result.
Apply button	Press this button for save current configuration of Managed Media Converter.

Table 4-13 Descriptions of the Local TS-1000 OAM Setup Web Page Screen Objects

4.7.2 Remote TS-1000 OAM Setup

The Remote TS-1000 OAM Setup is an advanced remote device monitor feature that allows you to Remote monitor and automatic notify status indication.

Remote monitor

1. User instructs center Media Converter to issue a status notification request frame defined in TS-1000 to get status of terminal Media Converter.
2. Terminal Media Converter receives the status notification request frame and sends out status response frame, which carries its current status.

Autonomous notification

1. Terminal Media Converter notifies the center Media Converter autonomously with a status notification indication, if any change occurs in the status monitored internally by the terminal Media Converter.
2. Center Media Converter if support Option A, notifies the terminal Media Converter autonomously with a status notification indication, if any change occurs in the status monitored internally by the center Media Converter.

This function provides Remote TS-1000 OAM Setup of Managed Media Converter. Press the “**Apply**” button to save the current configuration of Managed Media Converter. The screen in [Figure 4-36 & 4-37](#) appears.

The screenshot displays the Planet Managed Media Converter web interface. The left sidebar contains navigation menus for System, Port Management, Converter Configuration, VLAN, Quality of Service, OAM Setup, and Security. The OAM Setup menu is expanded, showing options like Local TS-1000 OAM Setup, Remote TS-1000 Setup, and various loop back tests. The main content area is titled 'Remote Port Configuration' and features a table with columns for Port, Admin, Mode, Flow Control, Ingress Rate Limit, and Egress Shaping. Below this table is an 'Apply' button. The second section is 'TS-1000 OAM Remote Information', which includes a table for Machine Name, Remote IP Address, Remote MAC Address, and a detailed table for Port, Link Status, Speed, Duplex Mode, and Flow Control. A 'Refresh' button is located at the bottom of this section.

Port	Admin	Mode	Flow Control	Ingress Rate Limit	Egress Shaping
TP	Link Up	Auto Speed	Disabled	No Limit	No Limit
Fiber	Link Up	Auto Speed	Disabled	No Limit	No Limit

Apply

Machine Name	GT-80X			
Remote IP Address	0.0.0.0			
Remote MAC Address	00.00.00.00.00.00			
Port	Link Status	Speed	Duplex Mode	Flow Control
TP	Link Down	10	Half	Enable
Fiber	Link up	1000	Full	Enable

Refresh

Figure 4-36 GT-80x Remote TS-1000 OAM Setup Web Page screen

The screenshot displays the PLANET Managed Media Converter web interface. On the left is a navigation menu with categories: System, Port Management, Converter Configuration, VLAN, Quality of Service, and OAM Setup. Under OAM Setup, there are links for Local TS-1000 OAM Setup, Remote TS-1000 Setup, TS-1000 Loop Back Test, 802.3ah Setup, and 802.3ah Loop Back Test. A Security section and a Logout button are also visible.

The main content area is titled "Remote Port Configuration" and contains a table with the following data:

Port	Admin	Mode	Flow Control	Ingress Rate Limit	Egress Shaping
TP	Link Up	Auto Speed	Disabled	No Limit	No Limit
Fiber	Link Up	Auto Speed	Disabled	No Limit	No Limit

Below this table is an "Apply" button.

The section below is titled "TS-1000 OAM Remote Information" and contains a table with the following data:

Machine Name	GT-90X			
Remote IP Address	192.168.0.1			
Remote MAC Address	00-30-4F-11-22-34			
Port	Link Status	Speed	Duplex Mode	Flow Control
TP	Link Down	10	Half	Disable
Fiber	Link up	1000	Full	Disable

Below this table is a "Refresh" button.

Figure 4-37 GT-90x Remote TS-1000 OAM Setup Web Page screen

Notice: Please use the PLANET GT-80x and GT-90x as the Remote device.

4.7.3 TS-1000 Loop Back Test

The TS-1000 Loop Back Test allows manual run this loop back test to check the interconnection between two Media Converter devices. To assure the Remote TS-1000 OAM function can work correctly.

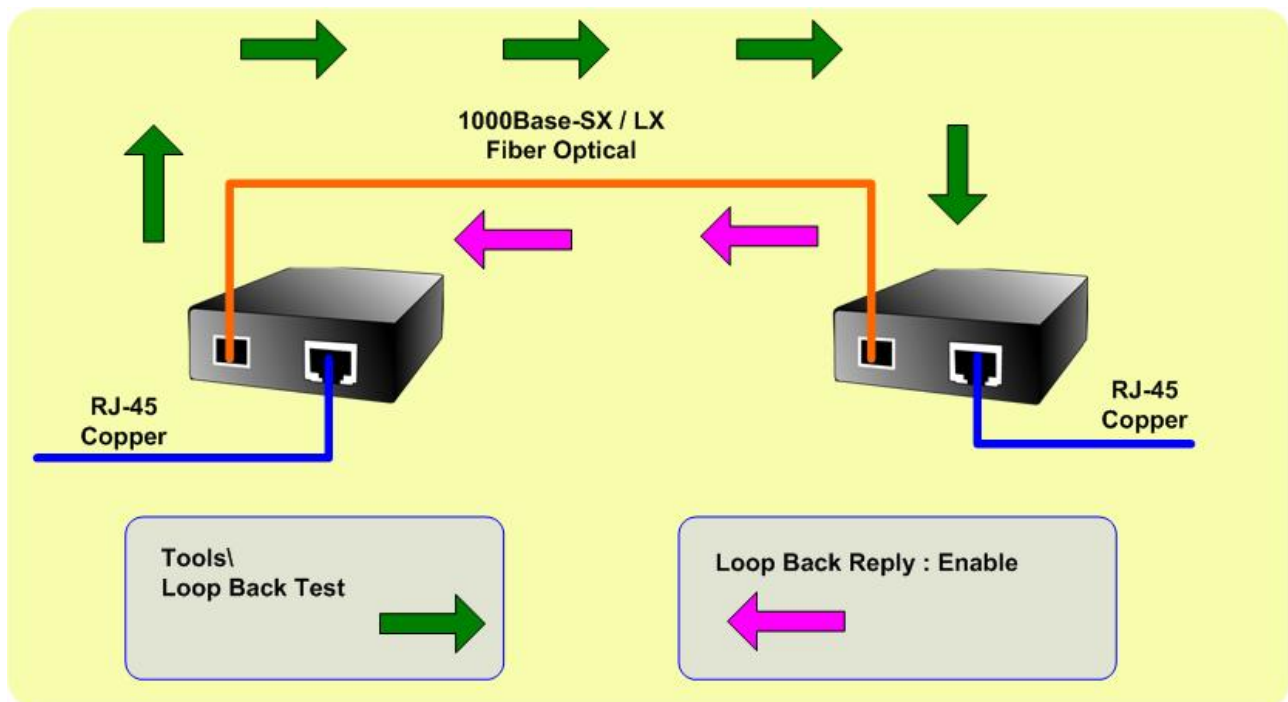

In-band and out-band Loop back

1. Instruct center Media Converter to issue an OAM frame to request a loop back test. Terminal return start response OAM frame to center Media Converter.
2. Terminal Media Converter runs at loop back mode.
3. Central Media Converter send test frame and terminal Media Converter loop back the frames. Test frame can be generated from central Media Converter's UTP port (Out-Band) or from central Media Converter (In-Band) automatically.
4. Center Media Converter check the loop back test result after sending all test frames
5. Instruct the central Media Converter to end loop back test.

This function provides TS-1000 Loop Back Test of Managed Media Converter. Press the “**Apply**” button to run Loop Back Test and see the TS-1000 Loop Back Test Result of Managed Media Converter, also press the “**Refresh**” button to renew the Web screen. The screen in [Figure 4-38](#) appears and [Table 4-14](#) describes the TS-1000 Loop Back Test object of Managed Media Converter.

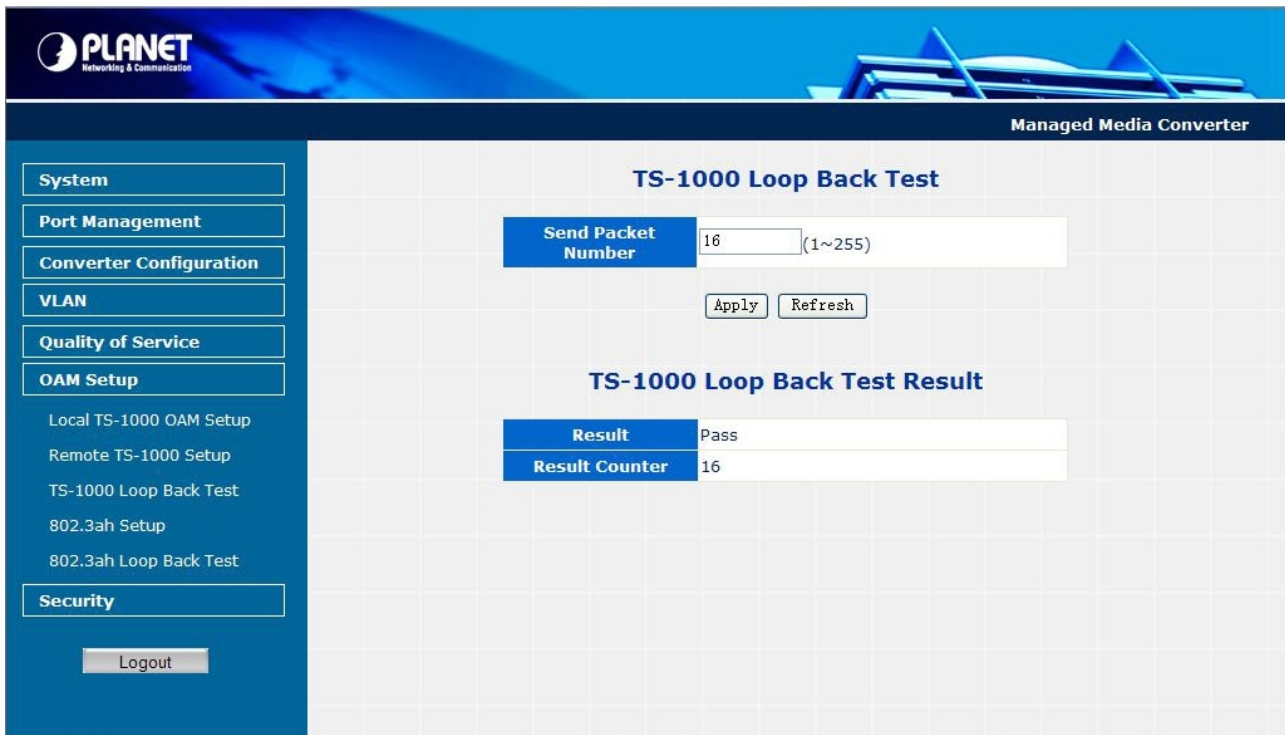

Figure 4-38 Remote TS-1000 Loop Back Test Web Page screen

The TS-1000 Loop Back Test Web page includes the following configurable data:

TS-1000 Loop Back Test	
Send Packet Number	Allow input the number for packet send and the available options is 1 to 255. Default is 16 .
Apply button	Press this button for save current configuration of Managed Media Converter.
Refresh button	Press " Refresh " button to refresh current status.
TS-1000 Loop Back Test Result	
Result	Display the TS-1000 Loop Back Test Result. Fail or Pass.
Result counter	Display the value of Counter Result.

Table 4-14 Descriptions of the TS-1000 Loop Back Test Web Page Screen Objects

Notice: Please use the PLANET GT-80x and GT-90x as the Remote device.

4.7.4 802.3ah Setup

When enable 802.3ah OAM function, all 802.3ah OAMPDU packets will trap to embedded CPU.

Software will implement auto discovery procedure. With hardware support, software controls the 802.3ah remote loop back procedure. Hardware can also detect dying gasp even and interrupt CPU to send dying gasp even notification OAMPDU. All other functions defined by 802.3ah are implemented using embedded CPU.

When remote device is in loop back mode, hardware can support change looped test frame's DA, SA or both as user defined. Hardware can also set to don't change looped test frame.

This function provides 802.3ah Setup of Managed Media Converter. Press the “**Apply**” button to save the current configuration of Managed Media Converter. The screen in [Figure 4-39](#) appears and [Table 4-15](#) describes the 802.3ah Setup object of Managed Media Converter.

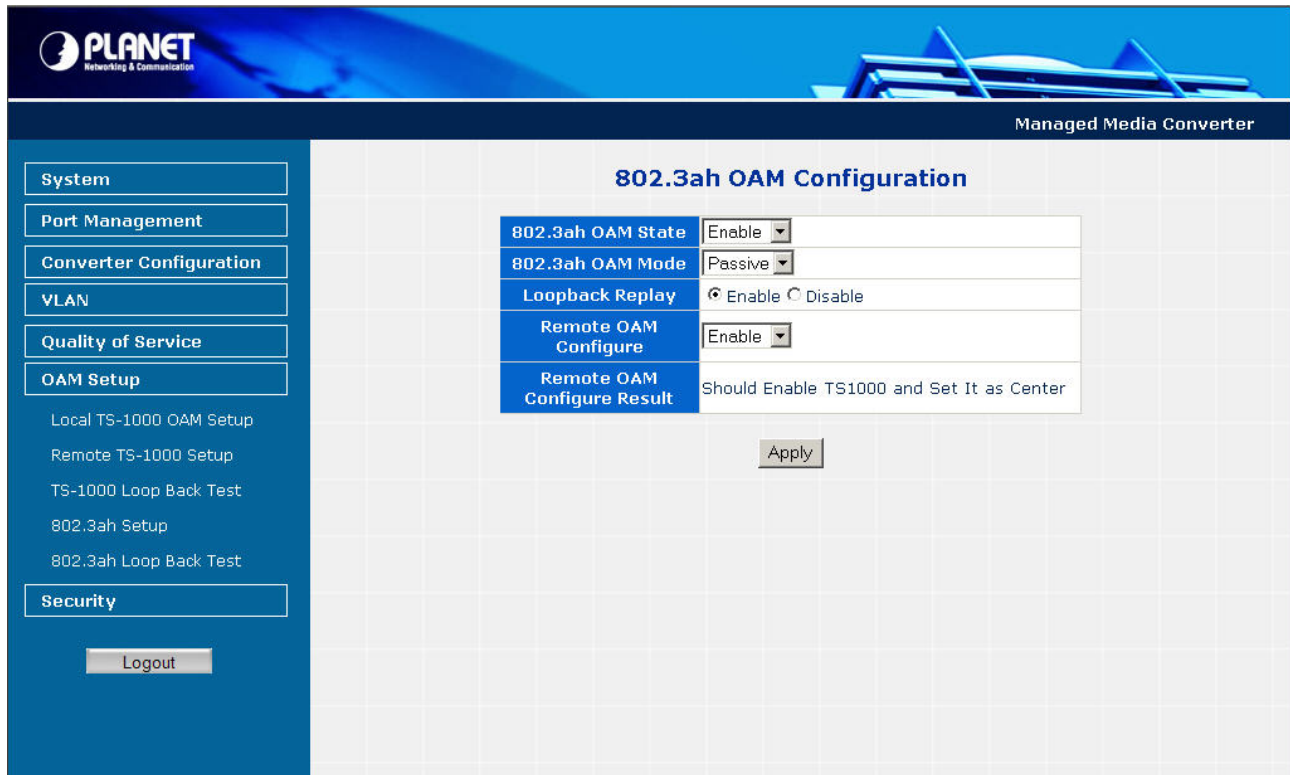

Figure 4-39 802.3ah Setup Web Page screen

The 802.3ah Setup Web page includes the following configurable data:

802.3ah OAM State	Provide disable or enable the 802.3ah OAM State function. Default mode is Enable .
802.3ah OAM Mode	Allow to choose “ Active ” or “ Passive ” for 802.3ah OAM Mode. Default mode is Passive .
Loopback Reply	Provide disable or enable the Loopback Reply function. Default mode is Enable .
Remote OAM Configure	Provide disable or enable the Remote OAM Configure function. Default mode is Enable .
Remote OAM Configuration Result	Display the Remote OAM Configuration Result.
Apply button	Press this button for save current configuration of Managed Media Converter.

Table 4-15 Descriptions of the 802.3ah Setup Web Page Screen Objects

-
- Notice:** 1. The 802.3ah function must work with manageable device that supports 802.3ah function.
2. Please use the PLANET GT-90x as the Remote device.
-

4.7.5 802.3ah Loop Back Test

The 802.3ah Loop Back Test allows manual run this loop back test to check the interconnection between two Media Converter devices. To assure the Remote 802.3ah function can work correctly.

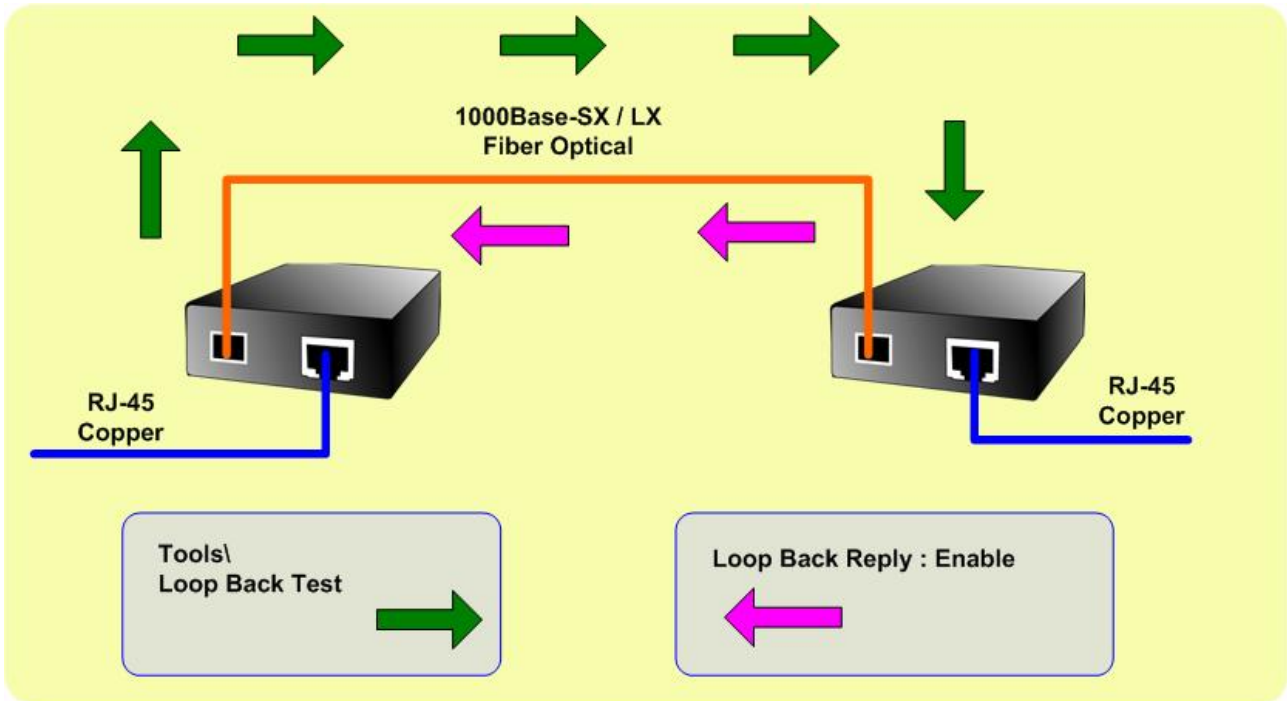

This function provides 802.3ah Loop Back Test of Managed Media Converter. Press the “**Apply**” button to run 802.3ah Loop Back Test and see the 802.3ah Loop Back Test Result of Managed Media Converter, also press the “**Refresh**” button to renew the Web screen. The screen in [Figure 4-40](#) appears and [Table 4-16](#) describes the 802.3ah Loop Back Test object of Managed Media Converter.

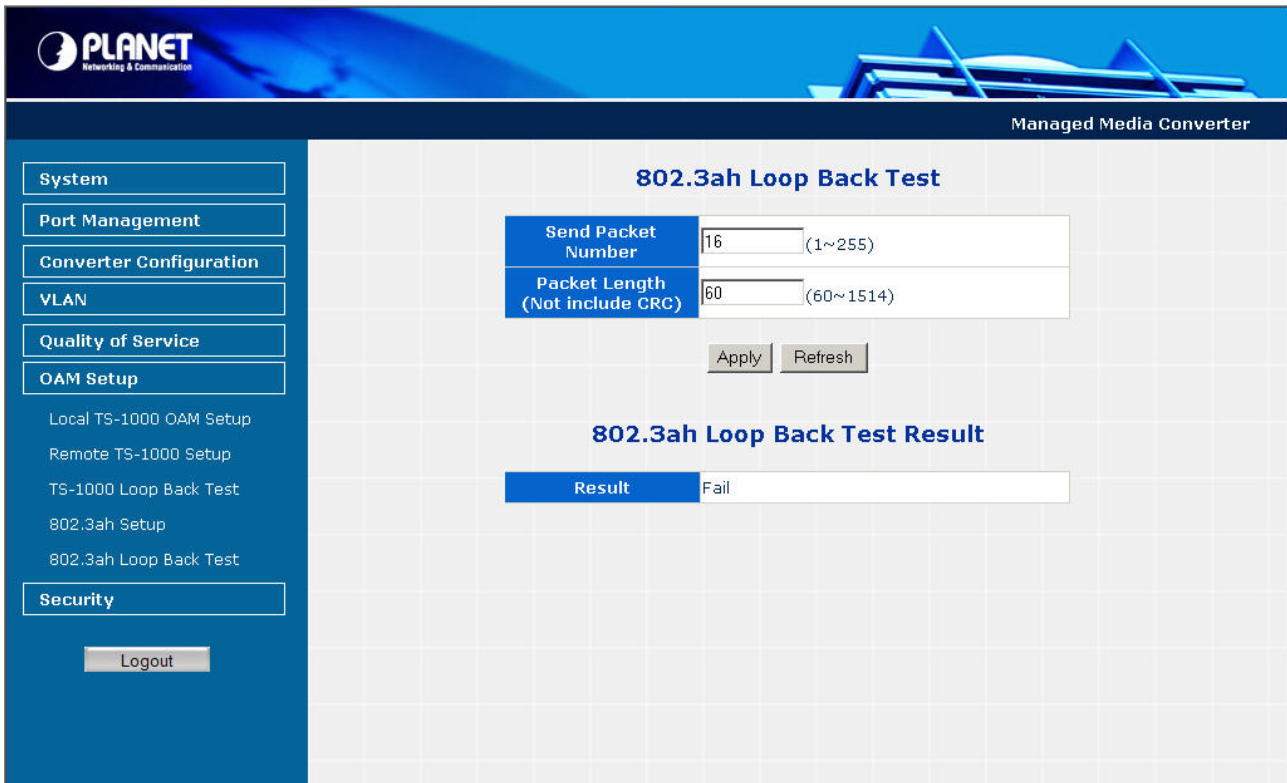

Figure 4-40 802.3ah Loop Back Test Web Page screen

The 802.3ah Loop Back Test Web page includes the following configurable data:

802.3ah Loop Back Test	
Send Packet Number	Allow input the number for packet send and the available options is 1 to 255. Default is 16 .
Packet Length (Not include CRC)	Allow input the number for Packet Length and the available options is 60 to 1514. Default is 60 .
Apply button	Press this button for save current configuration of Managed Media Converter.
Refresh button	Press “ Refresh ” button to refresh current status.
802.3ah Loop Back Test Result	
Result	Display the 802.3ah Loop Back Test Result. Fail or Pass.

Table 4-16 Descriptions of the 802.3ah Loop Back Test Web Page Screen Objects

-
- Notice:**
1. The 802.3ah function must work with manageable device that supports 802.3ah function.
 2. Please use the PLANET GT-90x as the Remote device.
-

4.8 Security

This function provides TCP / UDP Filter setting of Managed Media Converter. Press the “**Apply**” button to save the current configuration of Managed Media Converter. The screen in Figure 4-41 appears and Table 4-17 describes the TCP / UDP Filter setting object of Managed Media Converter.

Figure 4-41 Security setting Web Page screen

The Quality of Service Web page includes the following configurable data:

Group ID	Provide input the group ID for TCP / UDP Filter and the available range is 1 to 16.
Action	Provide “ Deny ” or “ Permit ” options and default mode is Permit .
Egress Port	Provide choose “ TP ” or “ Fiber ” as Egress Port. Default mode is TP .
Packet Type	Provide IPv4 and Non-IPv4 protocol for further setting.
L4 Protocol	Provide IPv4 and Non-IPv4 protocol for further setting. IPv4: TCP Any / FTP (21) / HTTP (80), UDP Any / TFTP (69) Non-IPv4: Any / ARP (0x0806) / IPX (0x8137)
Current List	Display current TCP / UDP Filter Groups.
Add button	Press this button for add new TCP / UDP Filter group into current list.
Del button	Press this button for delete existence TCP / UDP Filter group from current list.

Table 4-17 Descriptions of the Security setting Web Page Screen Objects

4.9 Logout

This function provides Logout function of Managed Media Converter, when the “**Are you sure to logout**” pop window appears; press the “**OK**” button to logout Web page of Managed Media Converter. The screen in [Figure 4-42 & 4-43](#) appears.

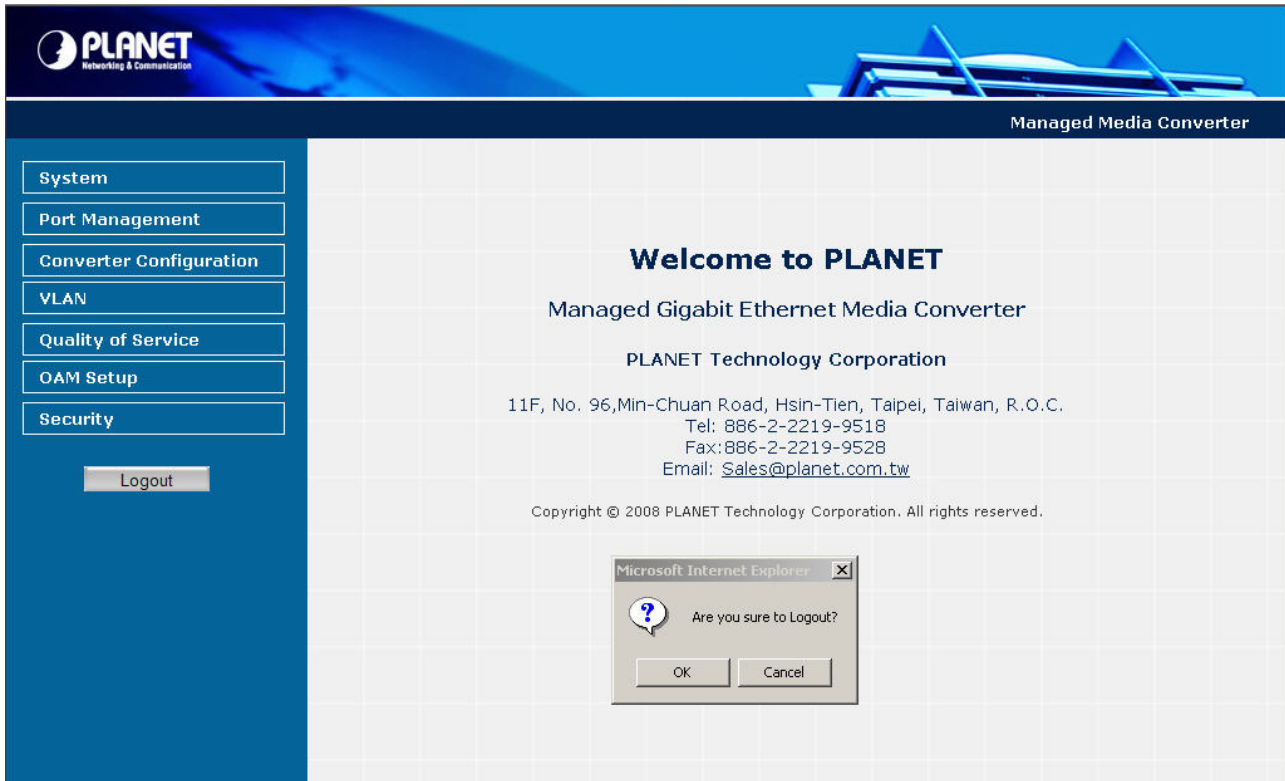

Figure 4-42 Logout Web Page screen

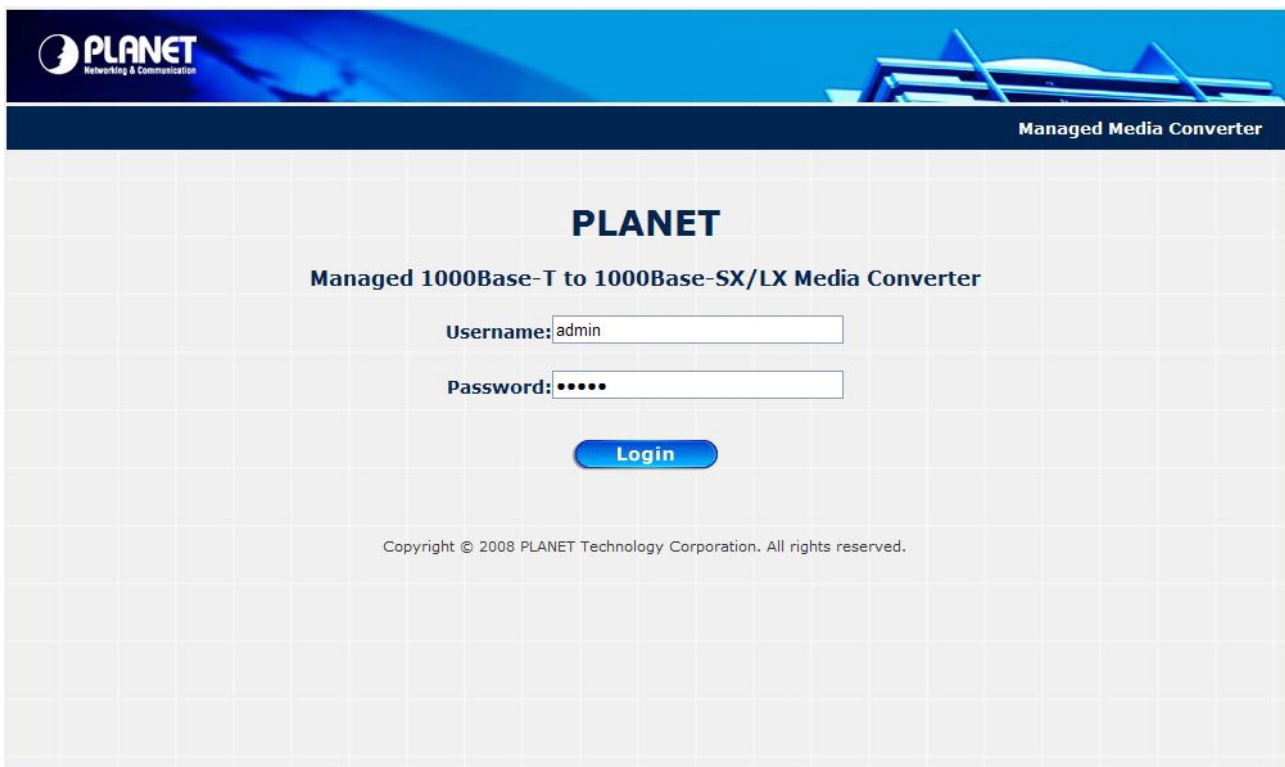

Figure 4-43 Login Web Page screen

5. TROUBLESHOOTING

This chapter contains information to help you solve problems. If the media converter is not functioning properly, make sure the media converter was set up according to instructions in this manual.

The Link LED is not lit

Solution:

1. Check the cable connection and remove duplex mode of the Managed Media Converter.
2. Check the port configuration of the link partner; make sure the two side devices with the same link configuration.

Performance is bad

Solution:

Check the full duplex status of the device. If the device is set to full duplex and the partner is set to half duplex, then the performance will be poor.

10/100/1000Base-T port link LED is lit, but the traffic is irregular

Solution:

Check that the attached device is not set to dedicate full duplex. Some devices use a physical or software switch to change duplex modes. Auto-negotiation may not recognize this type of full-duplex setting.

Why the device doesn't connect to the network

Solution:

Check the LNK/ACT LED on the Managed Media Converter. Try another port on the connected device. Make sure the cable is installed properly. Make sure the cable is the right type. Turn off the power. After a while, turn on power again.

How to deal forgotten password situation of device?

Solution:

The Managed Media Converter is implemented with "Reset" button, press the button at the front panel about 10 seconds. After the device be rebooted. Login the Web Management page with default user name and password (admin).

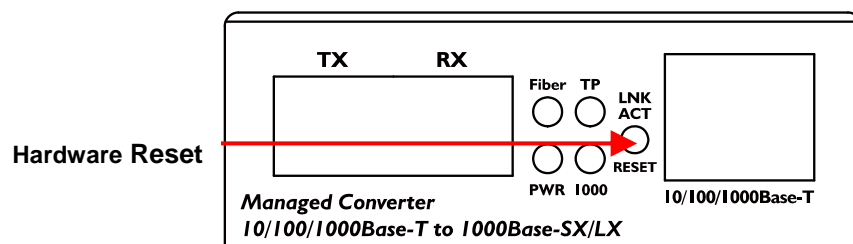

APPENDIX A NETWORKING CONNECTION

A.1 Device's RJ-45 Pin Assignments

■ 1000Mbps, 1000Base T

RJ-45 Connector pin assignment		
Contact	MDI	MDI-X
1	BI_DA+	BI_DB+
2	BI_DA-	BI_DB-
3	BI_DB+	BI_DA+
4	BI_DC+	BI_DD+
5	BI_DC-	BI_DD-
6	BI_DB-	BI_DA-
7	BI_DD+	BI_DC+
8	BI_DD-	BI_DC-

10/100Mbps, 10/100Base-TX

RJ-45 Connector pin assignment		
Contact	MDI Media Dependant Interface	MDI-X Media Dependant Interface -Cross
1	Tx + (transmit)	Rx + (receive)
2	Tx - (transmit)	Rx - (receive)
3	Rx + (receive)	Tx + (transmit)
4, 5	Not used	
6	Rx - (receive)	Tx - (transmit)
7, 8	Not used	

A.2 RJ-45 cable pin assignment

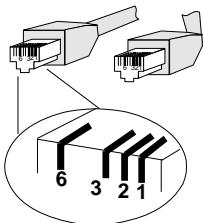

The standard RJ-45 receptacle/connector

There are 8 wires on a standard UTP/STP cable and each wire is color-coded. The following shows the pin allocation and color of straight cable and crossover cable connection:



Figure A-1: Straight-Through and Crossover Cable

Please make sure your connected cables are with same pin assignment and color as above picture before deploying the cables into your network.

A.3 Fiber Optical Cable Connection Parameter

The wiring details are as below:

■ **Fiber Optical patch Cables:**

Standard	Fiber	Diameter (micron)	Modal Bandwidth (MHz * km)	Max. Distance (meters)
1000Base-SX	Multi-mode	62.5	100	220
		62.5	200	275
		50	400	500
		50	500	550
1000Base-LX	Multi-mode	62.5	5	550
		50	4	
		50	5	
	Single-mode	9	N/A	5000*

A.4 Power Information

The power jack of Managed Media Converter is with 2.5mm in the central post and required +5VDC power input. It will conform to the bundled AC-DC adapter and Planet's Media Chassis. Should you have the problem to make the power connection, please contact your local sales representative.

Please keep the AC-DC adapter as spare parts when your Managed Media Converter is installed to a Media Chassis.

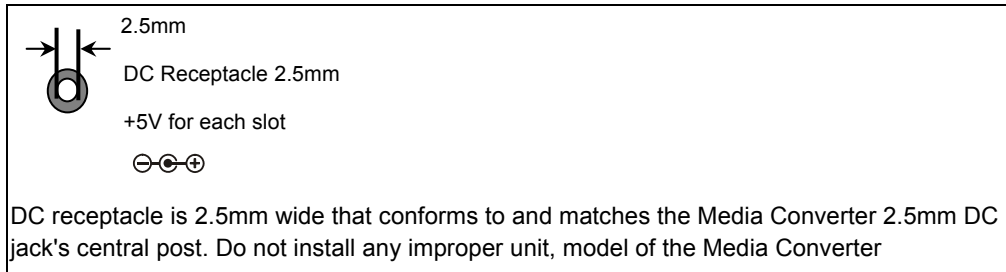

A.5 Available Modules

The following list the available Modules for GT-905A

MGB-GT	SFP-Port 1000Base-T mini-GBIC module
MGB-SX	SFP-Port 1000Base-SX mini-GBIC module
MGB-LX	SFP-Port 1000Base-LX mini-GBIC module
MGB-L30	SFP-Port 1000Base-LX mini-GBIC module -30KM
MGB-L50	SFP-Port 1000Base-LX mini-GBIC module -50KM
MGB-L70	SFP-Port 1000Base-LX mini-GBIC module -70KM
MGB-L120	SFP-Port 1000Base-LX mini-GBIC module -120KM
MGB-LA10	SFP-Port 1000Base-LX mini-GBIC module- LC WDM(TX:1310nm), SM,10km
MGB-LB10	SFP-Port 1000Base-LX mini-GBIC module- LC WDM(TX:1550nm), SM,10km
MGB-LA20	SFP-Port 1000Base-LX mini-GBIC module- LC WDM(TX:1310nm), SM,20km
MGB-LB20	SFP-Port 1000Base-LX mini-GBIC module- LC WDM(TX:1550nm), SM,20km
MGB-LA40	SFP-Port 1000Base-LX mini-GBIC module- LC WDM(TX:1310nm), SM,40km
MGB-LB40	SFP-Port 1000Base-LX mini-GBIC module- LC WDM(TX:1550nm), SM,40km

EC Declaration of Conformity

For the following equipment:

*Type of Product : 10/100/1000Base-T to 1000Base-SX/LX Managed Gigabit Converter
 *Model Number : **GT-90xynn**
 x: can be 2,5,6;
 y: can be blank or S, A, B;
 nn: can be blank or 15,60 for different distance

* Produced by:
 Manufacturer's Name : **Planet Technology Corp.**
 Manufacturer's Address : 11F, No. 96, Min Chuan Road, Hsin Tien,
 Taipei, Taiwan, R.O.C.

is herewith confirmed to comply with the requirements set out in the Council Directive on the Approximation of the Laws of the Member States relating to Electromagnetic Compatibility Directive on (89/336/EEC).

For the evaluation regarding the EMC, the following standards were applied:

Emission	EN 55022	(1994 + A1:1995 + A2:1997)
Harmonic	EN 61000-3-2	(2000)
Flicker	EN 61000-3-3	(1995 + A1:2001)
Immunity	EN 55024	(1998)
ESD	IEC 61000-4-2	(2001)
RS	IEC 61000-4-3	(1995)
EFT/ Burst	IEC 61000-4-4	(1995)
Surge	IEC 61000-4-5	(1995)
CS	IEC 61000-4-6	(1996)
Magnetic Field	IEC 61000-4-8	(1993)
Voltage Disp	IEC 61000-4-11	(1994)

Responsible for marking this declaration if the:

Manufacturer **Authorized representative established within the EU**

Authorized representative established within the EU (if applicable):

Company Name: **Planet Technology Corp.**

Company Address: **11F, No.96, Min Chuan Road, Hsin Tien, Taipei, Taiwan, R.O.C**

Person responsible for making this declaration

Name, Surname **Kent Kang**

Position / Title : **Product Manager**

Taiwan
Place

27, Oct., 2008
Date



Legal Signature

PLANET TECHNOLOGY CORPORATION